



FINAL REPORT

CHARLESTOWN CULTURAL DISTRICT DESIGN GUIDELINES LAKE CHARLES, LOUISIANA

APRIL 2012



PREPARED FOR:
LOUISIANA DIVISION OF HISTORIC PRESERVATION

PREPARED BY:
HARDY•HECK•MOORE, INC.
AUSTIN, TEXAS

FINAL REPORT

CHARLESTOWN CULTURAL DISTRICT DESIGN GUIDELINES
LAKE CHARLES, LOUISIANA

APRIL 2012

PREPARED FOR:

LOUISIANA DIVISION OF HISTORIC PRESERVATION

PREPARED BY:

HARDY•HECK•MOORE, INC.
AUSTIN, TEXAS

TABLE OF CONTENTS

- Purpose and Goals..... 1
- How to Use the Design Guidelines 1
 - What are Design Guidelines? 1
 - Why have Design Guidelines? 1
 - Who uses Design Guidelines? 2
 - When to use Design Guidelines?..... 2
 - Where do the Design Guidelines Apply?..... 2
 - Organization of the Document..... 2
 - Structure of the Design Guidelines 2
- History and Development of Lake Charles, Louisiana, and the Charlestown Cultural District 5
- Design Review Process for the Charpentier Historic District 8
- Design Review Process for the Downtown Development District 14
- Architectural Character of Charlestown Cultural District 16
 - Building Forms..... 17
 - Architectural Styles 38
 - Landscape and Streetscape Features 58
- Charlestown Cultural District Design Guidelines..... 61
 - General..... 61
 - Retention of Historic Style 61
 - Avoidance of False Historicism..... 61
 - Sequence of Appropriate Treatment Options..... 61

Architectural Barriers and Accessibility.....	61
Energy Efficiency	61
Rehabilitation of Contributing Buildings	61
Exterior Walls/Murals	63
Porches.....	65
Roofs.....	66
Storefronts	67
Canopies and Awnings	68
Windows, Screens, and Shutters.....	69
Doors	81
Chimneys	87
Mechanical Equipment.....	88
Signage	89
Landscape and Streetscape Features.....	90
Additions to Contributing Buildings	93
Preservation of the Original Building	93
Location and Height	93
Massing and Roof Form.....	93
Design and Style	99
Exterior Walls	99
Roofs.....	99
Windows and Screens	99
Doors	99

Non-Contributing Buildings	100
New Construction in Charlestown Cultural District	101
Orientation, Set-backs, and Height	101
Design and Style	101
Exterior Walls	107
Porches.....	107
Roofs.....	107
Windows and Screens	107
Doors	107
Chimneys	107
Garages and Accessory Buildings	108
Independent Fences and Walls	108
Landscaping.....	108
Relocation and Demolition in Charlestown Cultural District	109

APPENDICES

Appendix A: Glossary.....	111
Appendix B: Map of Charlestown Cultural District	116
Appendix C: Maps of Charpentier Historic District	117
Appendix D: Inventory of Properties in Charpentier Historic District and Calcasieu Historical Preservation Society Landmarks	119
Appendix E: Secretary of the Interior’s Standards for Rehabilitation	133
Appendix F: Treatment Guidelines for Historic Building Materials.....	134
Appendix G: Federal and State Tax Incentives Reference Guide	138

Appendix H: Additional Resources 139
Appendix I: List of “Items Necessary for Planning Commission/Conditional Use Permit Application” 142
Appendix J: Lakefront/Downtown Development Review Form..... 143

PURPOSE AND GOALS

The City of Lake Charles was one of several communities selected by the Louisiana Division of Historic Preservation to receive design guidelines for historic resources. The guidelines are intended for the Charlestown Cultural District, comprised of the Charpentier Historic District and the Downtown Development District. The purpose of the design guidelines is to enable property owners contemplating renovation and/or restoration within the Charlestown Cultural District to maintain the historic look, feel, and character of the district. The guidelines also address new additions to historic buildings and new construction within the historic district. The goal is to encourage long-term planning for historic district resources in Louisiana that were negatively impacted by Hurricanes Katrina and Rita. The intended result is an improved quality of the district that will contribute to the economic health of the district and the community.

The Louisiana Division of Historic Preservation received federal funding for the development of design guidelines as a result of the Section 106 consultation process following Hurricanes Katrina and Rita. Section 106 of the National Historic Preservation Act requires that projects that entail federal funding or licensing take measures to avoid, minimize, or mitigate adverse effects to historic properties. The Louisiana State Historic Preservation Office, the Louisiana Division of Historic Preservation, and the Louisiana Division of Archaeology together conduct review of federal projects under Section 106. Following Hurricanes Katrina and Rita, the Louisiana Division of Historic Preservation determined that recovery efforts undertaken by the Office of Community Development (OCD) under the Road Home Program had an adverse effect on historic properties. The Road Home Program is supported by Community Block Grant funds provided by the U.S. Department of Housing and Urban Development

(HUD). In order to mitigate the adverse effect, the Louisiana Division of Historic Preservation received Community Block Grant funds to develop design guidelines to insure that historic resources are protected in the future.

Designated Landmarks and Historic Districts

The design guidelines contained within apply to resources in the Charlestown Cultural District as designated by the City of Lake Charles. A map illustrating the boundaries of the Charlestown Cultural District (which includes the Charpentier Historic District and Downtown Development District) is included in *Appendix B*. Maps illustrating the boundaries of the Charpentier Historic District are located in *Appendix C*. An inventory listing contributing and non-contributing resources in the Charpentier Historic District and a list of Calcasieu Historical Preservation Society landmarks properties to date is included in *Appendix D*.

How to Use the Design Guidelines

What are Design Guidelines?

Design guidelines convey recommendations on renovations, restorations and, new additions to existing buildings and to the historic district as a whole.

Why have Design Guidelines?

Design guidelines enable a general understanding of historic preservation principles and standards to allow for the retention of the historic character of the Charlestown Cultural District which is irreplaceable and, therefore, vulnerable to inappropriate alterations and demolition.

Who uses Design Guidelines?

The design guidelines are intended for use by the City of Lake Charles Historic Preservation (HPC) in regulating the city's historic preservation ordinance. The guidelines are also intended for use by property owners, or professionals assisting them, in making decisions about renovation, restoration, and new construction projects that will affect individual buildings in the district and the overall historic character of the district. The design guidelines are also useful for real estate professionals, allowing them to educate themselves and potential homeowners in a historic district.

When to use the Design Guidelines

The design guidelines should be used for projects that will affect the integrity and significance of historic properties and, therefore, the districts in which they are located. The National Park Service defines integrity as "the ability of a property to convey its significance." Significance means that a property "must represent a significant part of the history, architecture, archeology, engineering, or culture of an area, and it must have characteristics that make it a good representative of properties associated with that aspect of the past." The Charlestown Cultural District contains a concentration of properties that represent the residential and commercial development of Lake Charles from the late nineteenth century to the 1960s.

Where do the Design Guidelines apply?

The Design Guidelines apply to all resources within Charlestown Cultural District (see maps in *Appendix B* and *Appendix C*).

Organization of the Document

The document is divided into the following sections:

- **Purpose and Goals:** Provides background of the efforts of the Louisiana Division of Historic Preservation and City of Lake

Charles to prepare guidelines for the Charlestown Cultural District and on how to use the document.

- **History and Development of Lake Charles, Louisiana, and the Charlestown Cultural District:** Summarizes the history of the City of Lake Charles and the development of the Charpentier Historic District and the Downtown Development District to provide a context as to why the Charlestown Cultural District is significant.
- **Architectural Character of the Charlestown Cultural District:** Defines and illustrates the types of building forms and architectural styles in the district. Also, describes the physical character of the landscape and streetscape in the district.
- **Charlestown Cultural District Guidelines:** Contains general information on the treatment of historic buildings with sections specifically on rehabilitation, additions, and new construction. Distinguishes between Contributing and Non-contributing buildings in the district and how to apply the guidelines to each.
- **Appendices:** Provide supplemental information to aid in the use of this document.

Structure of the Design Guidelines

The design guidelines for Rehabilitation of Contributing Buildings, Additions to Contributing Buildings, and New Construction in Historic Districts includes several components that constitute the criteria the HPC will use to make design review decisions.

- **Design Element:** The guidelines are grouped into pertinent design element categories (i.e. design and style, exterior walls, windows and screens, door, etc.).
- **Photographs:** Thumbnail images of buildings and building components in the Charlestown Cultural District illustrating aspects of a particular design element.

- **Design Guidelines:** Recommendations on treatment of a certain design element. The guidelines are organized for reference, not in order of importance.

- **Illustrations:** Guidelines for a particular design element may be followed by additional images to support the guideline recommendations. Illustrations are not included for all guidelines.

Structure of the Design Guidelines.

DESIGN ELEMENT → Roofs

PHOTOGRAPHS →



The bell and clock tower are character-defining features of this building in the Italianate Style.



On this Classical Revival government building, the molded cornice, roof balustrades, and dome are important character-defining features.



The green tile roof, cornice, balustrade, and varied roof dormers are character-defining elements of the Queen Anne Style.



Note pyramidal roof, brackets, and eyebrow dormers at this tower on a home with Queen Anne elements.



The terracotta roof parapet with balustrade and cornice is an important feature of this Italianate commercial building.

GUIDELINES

- a. Use roofing materials that duplicate the appearance and profile of the original materials whenever possible. If the original roofing material previously has been replaced with composition shingle roofing, the existing roofing may be replaced with roofing materials that historically would have been appropriate for the building form and style. For example, if the roofing historically was wood shingle but has been replaced with composition shingle, it is acceptable to replace the existing composition shingle roof with a new composition shingle roof. Refer to the *Architectural Character* section of these design guidelines.
- b. Maintain the shape and slope of the original roof as seen from the street.
- c. Maintain and repair original decorative roof elements such as parapets or cornices. All repairs should meet the Secretary's

Standards for Rehabilitation and follow guidelines set forth in National Park Service *Preservation Briefs*. (Refer to the treatment guidelines in *Appendix F*.)

- d. If replacement of deteriorated or missing elements is necessary, replace only those elements deteriorated beyond repair. The replacement element shall match the original in design, profile, finish, and texture.
- e. Do not add decorative roof elements that were not historically present.
- f. Roof sheathing should be properly ventilated.
- g. Protect a leaking roof with plywood and building paper until it can be properly repaired. Building owners should initiate the design review process as soon as a leak appears, and begin repair immediately upon receiving a Certificate of Appropriateness.

HISTORY AND DEVELOPMENT OF LAKE CHARLES, LOUISIANA, AND THE CHARLESTOWN CULTURAL DISTRICT

Calcasieu Parish was considered an attractive place to settle due to its access to various waterways, broad prairies for pasturage, and abundant timber lands. In 1781 French immigrant Barthelemy LeBleu and his wife established a home on English Bayou, six miles east of the future site of the City of Lake Charles, becoming the area's first non-native settlers. In 1800, another French immigrant, Charles Sallier, built his home on the banks of the lake that would later bear his name (Sallier Street runs east-west through his former homestead). Two years later, he married the LeBleu's daughter, the first white female born east of the Calcasieu River. As the use of given names was popular at the time, Sallier was referred to as "Mr. Charles." The lake near his homestead was therefore called "Charles' Lake." The surrounding area was called "Charleston" or "Charles Town."

Most early settlers were French or Spanish, but southerners from east of the Mississippi arrived in the 1810s and 1820s. Calcasieu Parish was created out of St. Landry Parish in 1840. "Charleston" became the parish seat in 1852 at the urging of Jacob Ryan, Jr. who had a sawmill on the lake and a home at Broad and Pujos streets. He sold property on present-day Ryan Street which became the core of downtown Lake Charles. In 1855, Daniel Goos established his mill on the lake, improving production methods and expanding the lumber trade between ports in Galveston and Mexico. "Charleston" was incorporated in 1861, but after dissatisfaction grew over the city's name, it was changed to Lake Charles in 1867. By the Civil War, Lake Charles remained a sparsely settled village confined primarily to the downtown area until the lumber boom of the 1880s.

After the Civil War, the city made a transition with the influx of immigrants from the northern and Midwestern states. Their

arrival was precipitated by the lumber boom brought on by the investments of northern lumber barons and the immigrant recruiting activities of J. B. Watkins and the American Land and Timber Company. Between 1880 and 1896, Lake Charles also acquired three rail lines which aided the transportation of goods and people through the area. Further, streetcar lines emerged in the downtown area in 1895. The city's population quadrupled, and many of the lumber barons and mill workers settled east of downtown in what is now the Charpentier Historic District. The word "charpentier" means "carpenter" in French and pays homage to those who built the homes in this new residential area from the finest woods—long leaf yellow pine, curly cypress, and curly pine—courtesy of the lumber industry. The homes ranged from modest residences to high style mansions blending features of Victorian architecture from the northern U.S. and local variations of Louisiana cottages and of the Colonial Revival Style.



Pujos at Kirkman streets, looking west, 1905 (Louisiana Digital Library).

Lake Charles' downtown also flourished from the late nineteenth century to the early twentieth century with the establishment of banks and other commercial enterprises as well as buildings to house traveling entertainers and other cultural pursuits. Though the 30 blocks of the city's central business district were destroyed by the Great Fire of 1910, it was quickly rebuilt.

By the 1920s, the prosperity of the lumber industry had diminished due to the lack of a deep water port. In 1922, Calcasieu Parish voters passed a bond to deepen and widen the Calcasieu River and Lake from the Intracoastal Canal to Lake Charles, providing a navigation route through the Intracoastal Canal to the Sabine River and to the Gulf of Mexico. After years of various channel improvements, the Port of Lake Charles was officially opened on November 30, 1926. The port served the remaining sawmills and pursuits of the expanding rice and petroleum industries. In 1926, though, streetcar line service ceased with the introduction of bus transportation, the downtown area continued to flourish. In the 1930s Ryan Street replaced Railroad Avenue as the city's commercial hub. The city's economy and physical growth was effected in the 1940s by further developments in the petroleum industry and the opening of the Calcasieu River Bridge in 1948.

The 1960s saw a different type of development in the city of Lake Charles with the demolition of many of the central business district's historic resources. In addition, the wharves and warehouses on the lake were torn down. Sixty-four acres of the lakeshore were filled to be occupied by the new Lake Charles Civic Center. Rebuilding of the historic downtown core has been ongoing since the 1980s and 1990s.



*Views of Ryan Street in 1905 (Louisiana Digital Library):
Top: looking south from Division Street
Center: looking north from Pujo Street
Bottom: looking south from the corner of Broad Street*

The Louisiana Department of Culture, Recreation, and Tourism administers the Cultural Districts Program, which seeks to generate community revitalization based on cultural activity through tax incentives. Together, the Downtown Development District and Charpentier Historic District comprise the Charlestown Cultural District, which was certified in 2009.

Charpentier Historic District was listed on the National Register of Historic Places in 1990 as the Lake Charles Historic District. Charpentier Historic District retains its historic integrity to convey the significance of the prosperity the lumber industry brought to Lake Charles, especially since none of the historic mills and other lumber-related complexes survive and the downtown area has lost some of its architectural integrity and historical associations. The district—which encompasses approximately 37 city blocks and 380 buildings—contains a large concentration of ca. 1880 to

1939 residential, commercial, governmental, religious, educational, and social buildings, in a variety of architectural styles that were popular from the late nineteenth century through the 1960s.

The Downtown Development District was established in the late 1990s. The district consists of:

- the downtown core of Lake Charles along Ryan Street;
- commercial and civic development west and south of downtown to the lakeshore and Pithon Coulée from the late nineteenth century to the present; and
- twentieth century commercial development along Interstate 10 to the Calcasieu River Bridge.

DESIGN REVIEW PROCESS FOR THE CHARPENTIER HISTORIC DISTRICT

Design Review Application

Before initiating any work that may affect the exterior of a resource within the Charpentier Historic District, the owner must submit an application for a Certificate of Appropriateness to the City of Lake Charles Historic Preservation Commission (HPC). The list of “Items Necessary for Planning Commission/Conditional Use Permit Application” is included in *Appendix I*.

Major Work

The HPC will review all applications proposing major work projects—alterations (change in the design, materials, or general appearance of a building) or new construction—within the district and shall grant or deny Certificates of Appropriateness contingent upon the applicant’s acceptance of specific conditions set forth by the HPC. The HPC is authorized to hear and decide appeals, variances, and special exceptions (see zoning ordinance).

The HPC will review applications for the following exterior alterations to historic resources:

- Any change to the design of general appearance of a building
- New construction
- Expansions of a building footprint
- Changes in original materials
- Demolition of a historic building or structure
- Relocation of a historic building or structure

The HPC strongly discourages demolition and relocation of historic resources. Special instructions for applications involving demolition or relocation are found in the zoning ordinance at Section 5-307(17). Applications for alternate uses (uses not

specified in the zoning district) of a historic resource are discussed at Section 5-307(19).

Minor Work

Minor work projects are reviewed by the Director of Planning or an appointee. The application for minor work projects will be approved or denied within five working days of receipt by the Director of Planning. Exterior alterations considered to be minor work projects include:

- Installation of/alteration to awnings, gutters, and downspouts
- Incandescent lighting fixtures
- Restoration of original architectural features constituting a change of existing non-historic conditions
- Additions and changes not visible from any street of public right-of-way and located to the rear of the main structure
- Additions and changes to an accessory structure

The Director of Planning may refer minor work applications to the HPC if the changes are deemed by the Director and/or Planning staff to involve alterations, additions, or removals that are substantial; do not meet the guidelines for minor work; or are a precedent-setting nature. A checklist delineating minor work from major work is available from the Director of Planning by request.

Routine Maintenance

Routine maintenance of properties within the Charpentier Historic District does not require a Certificate of Appropriateness. Work that consists of routine maintenance, defined as “any work that does not constitute a change in design, material or outward

appearance of the structure, and it includes in-kind replacement or repair,” shall be determined by the Director of Planning. Paint colors are not regulated in the Charpentier Historic District.

Review Process

The process for HPC review is set forth in the Lake Charles Historic Preservation Ordinance (Ordinance No. 15813, adopted April 6, 2011) found in the *Zoning Ordinance for the City of Lake Charles*, Article V, Part 3, Section 5-307. The ordinance is available online at:

http://www.cityoflakecharles.com/egov/docs/1321550243_861602.pdf

Applicants are strongly encouraged to request a pre-application conference with the City of Lake Charles Director of Planning to discuss aspects of the proposed project. Applications for a Certificate of Appropriateness will be reviewed by the HPC within 30 days of receipt and being deemed complete by the HPC. Incomplete applications are not reviewed. Each proposed Certificate of Appropriateness is discussed at a public hearing. The public hearing process is outlined in Section 4-201(4)(b) of the city’s zoning ordinance.

The HPC will use these design guidelines when reviewing the Design Review Application. Additional criteria for approval are presented in the *Zoning Ordinance for the City of Lake Charles* at Section 5-307(10)(a-g).

HPC decisions will be rendered in writing. If the application is not approved, the HPC may suggest alternatives. The applicant may then modify the project in accordance with the HPC’s decision and resubmit the application.

Appeals Process

An applicant may appeal the HPC’s written decision to the City Council within 10 days from the date of the written decision but not more than 15 days after the commission’s decision is rendered.

The Lake Charles City Council will then give notice of public hearing, follow publication procedures, hold hearings and make its final decision in the same manner as provided for in the city’s general zoning ordinance (Section 4-201(4)(b)(ii)).

Responsibilities of the Applicant

The responsibility for demonstrating that the proposed project meets these design guidelines and historic preservation, zoning, and building codes lies with the applicant. In order to expedite the review process, it is helpful if the applicant submits the following documentation:

- Name, address, and telephone number of applicant;
- Detailed description of proposed work;
- Location and current photograph of the property and adjacent properties. Historical photographs are helpful;
- Scaled elevation drawings of building or structure and proposed changes showing all sides that are visible by pedestrians from any public right-of-way;
- Building material schedules including all façade materials (i.e. foundation, walls, trim, windows, and doors);
- Scaled site plan detailing placement of building or structure on property;
- Sample of materials to be used and product brochures;
- If the design review application includes signs or lettering, submit:
 - a scaled drawing showing the type of lettering,
 - dimensions and colors,

- a description of materials,
- method of illumination (if any),
- plan showing location of sign on property;
- Any other information that City staff or the HPC may deem necessary for review.

Penalties for Violation

If a contributing building or structure within a historic district is altered without complying with these design guidelines and the *Zoning Ordinance for the City of Lake Charles* and/or without obtaining a Certificate of Appropriateness, the

penalty may include reversal of unapproved alterations, permit delays, and fines. Failure to comply with the provisions of the historic preservation ordinance is a violation, and the violator will be punished with fines of \$10.00 to \$25.00 for each and every day that a violation continues.

Historic Preservation Application Process Flowchart

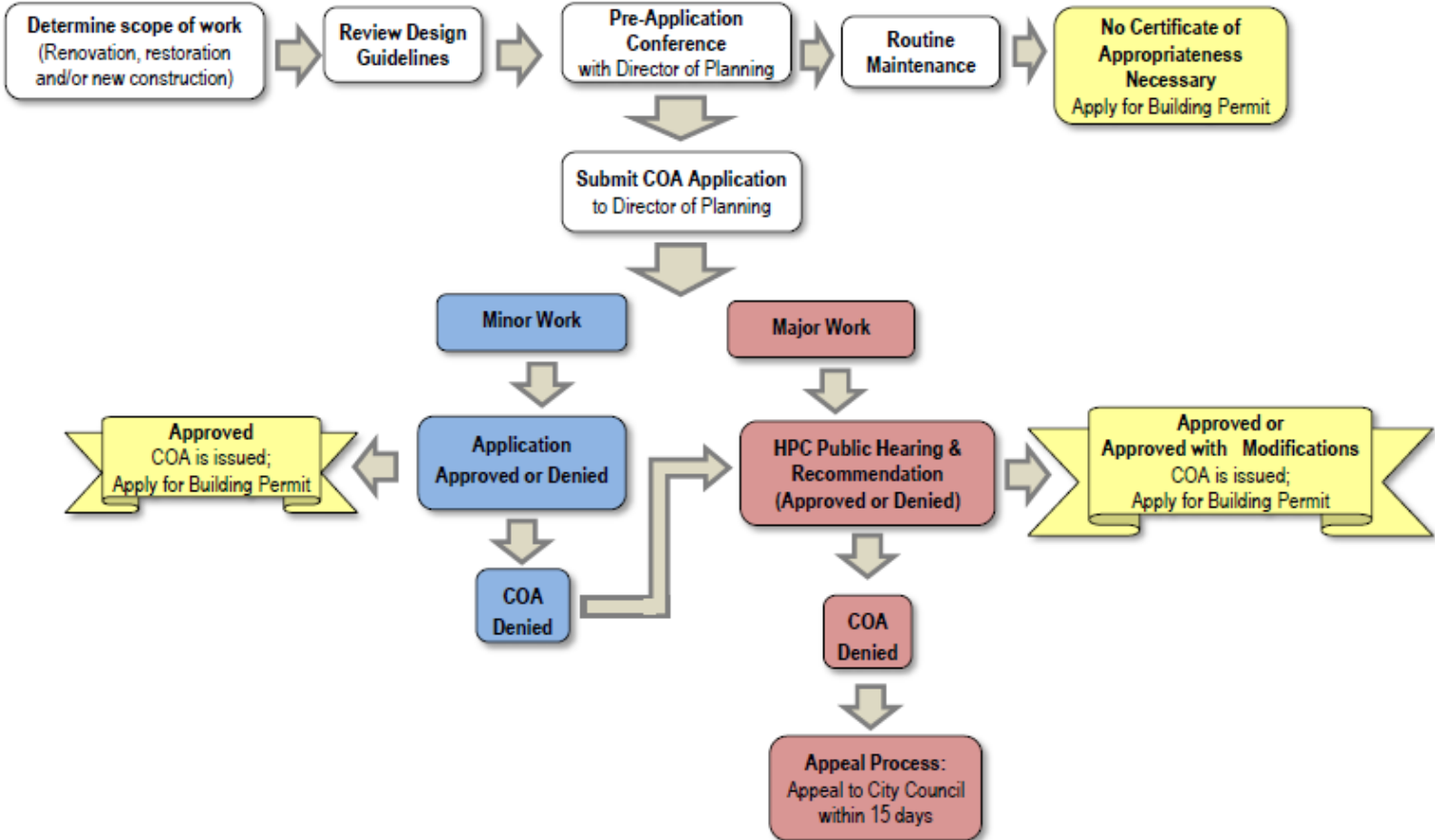

Disclaimer: The flowchart demonstrates only the major steps in the Application Process. Please see the Zoning Ordinance for the City of Lake Charles, Article V, Part 3, Section 5-307 for a complete explanation.

Types of Projects and Level of Review

Historic Preservation Commission Review	Staff Approval (Director of Planning)	No Certificate of Appropriateness
<p><u>Major Work Projects</u></p> <ul style="list-style-type: none"> • Any change to the design or general appearance of a building • New construction • Expansions of a building footprint • Changes in original materials • Demolition of a historic building or structure • Relocation of a historic building or structure <p>Examples (not all inclusive):</p> <ul style="list-style-type: none"> • <i>Construction of a new addition</i> • <i>Alteration or restoration of historic features</i> • <i>Removal or demolition in whole, or part, of a historic building</i> • <i>Alteration or restoration of a storefront</i> • <i>Application of new exterior siding</i> • <i>Addition of new window or door openings</i> • <i>Creation of a driveway or parking area</i> • <i>Application of architectural features (i.e. cornices, bulkheads)</i> 	<p><u>Minor Work Projects</u></p> <ul style="list-style-type: none"> • Installation of/alteration to awnings, gutters, and downspouts • Incandescent lighting fixtures • Restoration of original architectural features constituting a change of existing non-historic conditions • Additions and changes not visible from any street or public right-of-way and located to the rear of the main structure • Additions and changes to an accessory structure <p>Examples:</p> <ul style="list-style-type: none"> • <i>Removing inappropriately installed aluminum windows and replacing with original wood windows</i> 	<ul style="list-style-type: none"> • Routine Maintenance (as determined by Director of Planning) • Exterior painting • Interior alterations

Examples of Architectural Plans that may be required with COA Applications

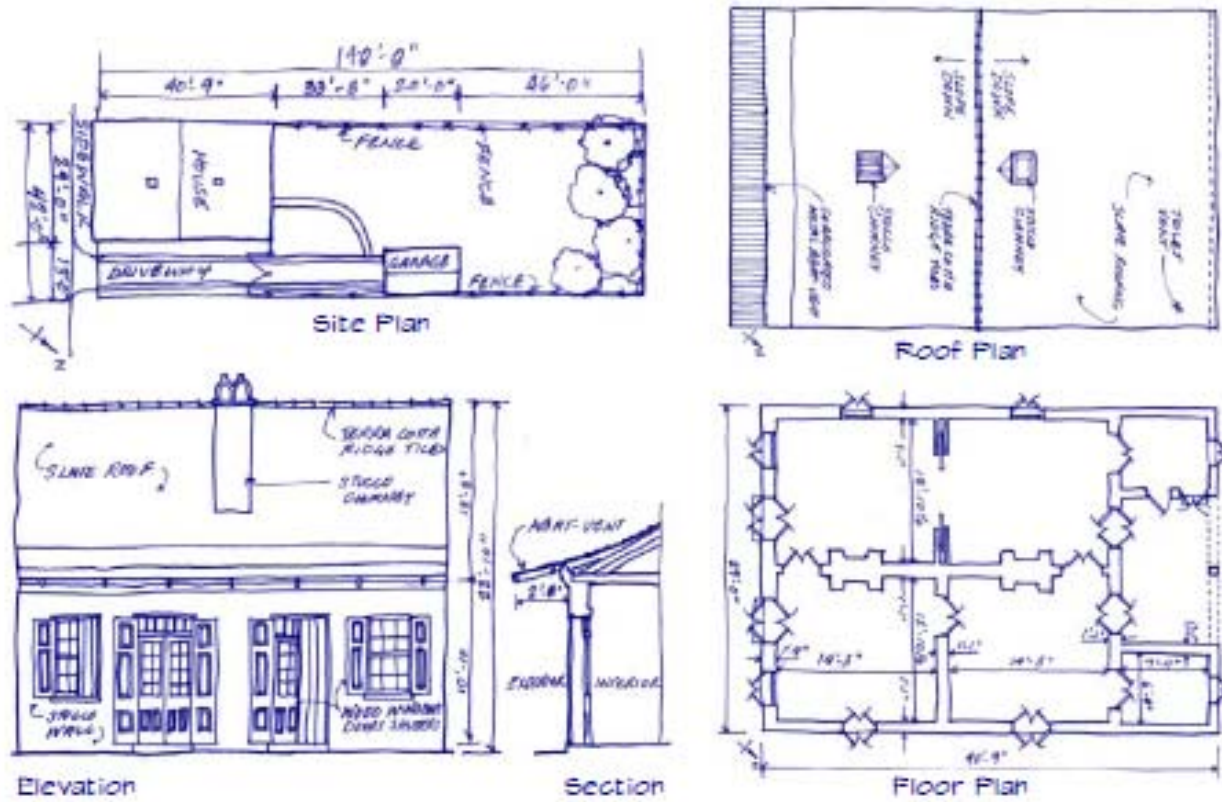

(Source: City of New Orleans Historic District Landmarks Commission Guidelines for New Construction, Additions and Demolition.)

DESIGN REVIEW PROCESS FOR THE DOWNTOWN DEVELOPMENT DISTRICT

Design Review Application

Before initiating any work that may affect the exterior of a resource within the Downtown Development District, the owner must obtain administrative approval from the Lake Charles Downtown Development Authority (DDA), a division of the City of Lake Charles Department of Planning and Development (designated by Ordinance No. 11646).

Review Process

The process for DDA review is set forth in the *Lake Charles Smart Code* found in the *Zoning Ordinance for the City of Lake Charles*, Article V, Part 3, Section 5-306. The *Smart Code* is available online at:

http://www.cityoflakecharles.com/egov/docs/1182532916_820739.pdf

Or

<http://library.municode.com/index.aspx?clientId=14023>

Applicants submit requests to the Planning Department. The Planning Department then forwards the Downtown Lakefront Development Review form (*Appendix J*) and development plans to the DDA. The DDA will review requirements described in the *Smart Code* as they relate to the disposition, configuration, and function of buildings in the Downtown Development District, as well as their architectural, landscape, parking, and signage standards.

After the DDA reviews the proposed plans:

- If NO deviations from the code are required, DDA comments and returns recommendations to the Planning Department
- If Deviations from the code ARE noted, DDA makes recommendations, citing each code Article and recommendation on the Downtown/Lakefront Development Review form and returns to the Planning Department.
- Planning director reviews Downtown/Lakefront Development Review recommendations submitted by the DDA and verifies if a warrant or variance is required.
 - If Warrant is required, Planning Director reviews recommendations and either approves or denies warrant request.
 - If Variance is required, Planning Director initiates the public hearing process, Section 4-201 of the Zoning code of ordinances.

In some cases, a proposed project may deviate from the requirements of the *Smart Code*. A variance permits a practice that is not consistent with the Purpose or provisions of the *Smart Code*. Variances are granted by the Planning Commission in a public hearing following existing procedures in existing local development codes. Warrants are granted administratively by the Consolidated Review Committee (CRC) for practices that are not consistent with *Smart Code* provisions but are justified by the Purpose of the *Code*.

After a proposed project is approved by the DDA, the owner of a building or property (or their developer or agent), should submit a written request to the DDA for the building scale plan to be placed on the next available meeting agenda of the Planning Commission for final plat approval.

A property owner (or their developer or agent) may appeal a DDA decision to the Planning Commission. A property owner (or their developer or agent) may appeal a decision of the Planning Commission to the Lake Charles City Council.

Responsibilities of the Applicant

The responsibility for demonstrating that the proposed project meets these design guidelines and the *Smart Code* (as well as zoning, and building codes) lies with the applicant. In order to expedite the review process, the applicant must submit the following documentation:

For preliminary site and building approval, site and building plans showing:

- Building disposition;
- Building configuration;
- Building function; and
- Parking standards

For final approval the above documentation required for preliminary approval with:

- Architectural standards;
- Landscape standards;
- Signage standards; and
- Any special requirements as designated by the *Smart Code* at Section 5-306, Article 2, Part 2.8.

Penalties for Violation

The Director of the Planning Department has several rights if violation of an approved plan occurs:

- Require the owner (or their developer or agent) to stop, remove, and/or mitigate the violation; or
- Require the owner (or their developer or agent) to secure a Variance to cover the violation.

ARCHITECTURAL CHARACTER OF CHARLESTOWN CULTURAL DISTRICT

Building forms and architectural styles are useful categories for analyzing general types of historic resources. The following list of the specific building forms and architectural styles found within the Charlestown Cultural District is based on a windshield survey of resources in the district and the NRHP inventory of the Charpentier Historic District.

The analysis within this section sets forth typical character-defining features of building forms and architectural styles. Note that many examples of historic resources do not strictly fit any

building form or architectural style classification. Similarly, a typical example of a building form or architectural style may exhibit some of the character-defining features defined below, but not all. Other examples of historic resources may combine elements from several building forms or architectural styles and present a more eclectic appearance. This analysis of building forms and architectural styles seeks to find commonalities among general trends, though the inventory of resources within a historic district inevitably will include exceptions.

BUILDING FORMS

Building form denotes the overall shape and axis of a building. Building form designation is primarily based upon the function intended for the building at the time of its construction, whether residential, commercial, or institutional. Because form follows function, properties that share a use-type often possess similarities in floor plan, roof form, size, and scale. Similar building forms often are clustered together due to a variety of factors influencing development, including proximity to transportation, property values, desire for visibility versus desire for privacy, and convenience. Building form classifications are based on a combination of the resource's original use or function, stylistic influences, and form/plan type. Although this system works well for the majority of the identified resources, some properties are unique and may not fall under a single standard building form classification.

The following building forms are found within the Charlestown Cultural District:

- Hall-and-Parlor Residence
- American Foursquare Residence
- L-Plan Residence
- Modified L-Plan Residence
- Center Passage Residence
- Shotgun Residence
- Bungalow Residence
- Ranch House
- Detached Garage
- One-Part Commercial Block
- Two-Part Commercial Block
- Temple-Front Building
- Enframed Commercial Block
- Central Block with Wings
- Two-Part Vertical Commercial Block
- Three-Part Vertical Commercial Block
- Commercial Block
- Service Station/Service Bay Business
- Religious Building

Hall-and-Parlor Residence



Example of a Hall-and-Parlor residence.

Hall-and-Parlor houses are one room deep and may be one, one-and-a-half, or two stories high. The interior composition consists of a single square room (the hall) with a smaller room (the parlor) attached to the side. A three- or five-bay symmetrical façade sometimes masks the imbalance of the asymmetrical interior. Chimneys may stand either internally or at the gable ends. These types of houses may be expanded with front porches and rear additions.

- Exterior Walls: Typically constructed with wood siding or wood shingles finished with paint.
- Foundations: Pier and beam, typically with brick or wood piers.
- Porches: May be entry, partial, or full-width. Usually feature timber, milled, or simple turned porch supports.
- Roofs: Originally usually wood shingle. Historic-age changes may include replacement with composition shingle, corrugated metal, or standing-seam metal roofs.
- Windows: Double-hung wood-sash, often with a two-over-two or four-over-four configuration.
- Doors: Typically paneled wood, sometimes with glazing.
- Chimneys: If present, original stone or brick masonry chimney at gable ends.

American Foursquare Residence



Example of an American foursquare residence.



An American foursquare residence with porch extension.

American foursquare houses are usually two- or two-and-a-half stories in height. Floor plans typically include four rooms on each floor, with an asymmetrically-located entry into one of the front rooms on the ground floor. In Lake Charles, these houses typically are set back with a front yard. Concrete sidewalks or driveway runners may be present. They often include a detached garage and/or a *porte cochere* attached to a side façade. The Charpentier Historic District contains several unique local examples of the American foursquare house where an extension of the second story forms a porch at the primary façade.

- Exterior Walls: Typically brick masonry, but sometimes constructed of milled lumber with wood siding finished with paint.
- Foundation: Pier and beam, typically with brick piers.
- Porches: Typically full-width with a front-gabled or shed roof form and wood or concrete porch floor. Often feature Craftsman Style tapered porch piers, sometimes on wood or stone bases. However, sometimes they feature Classical Revival Style, Tudor Revival Style, Spanish Colonial Revival Style, or Mission Revival Style porch supports and detailing.
- Roofs: Roof form typically low-pitched hipped or pyramidal. Originally usually standing seam metal or asphalt or asbestos shingle.
- Windows: Double-hung wood-sash, usually with a one-over-one configuration. Often feature wood screens with geometric detailing on the upper sash with Craftsman Style or Prairie Style motifs.
- Doors: Located asymmetrically, offset to one side of front façade. Typically paneled wood with glazing.
- Chimneys: Typically brick masonry chimney located at side façade.

L-Plan Residence



Example of an L-Plan residence.

L-Plan houses typically are one- or one-and-a-half stories in height with an L-shaped floor plan and a cross-gabled roof form. Historic-age rear additions are typical. L-Plan houses are usually set back with a front yard. Wood or cast-iron fences may be present. Original outbuildings may be present. Although not original, detached garages may have been added within the district's period of significance.

- Exterior Walls: Typically constructed with wood siding or wood shingles finished with paint, although occasionally brick or stone.
- Foundations: Pier and beam, typically with brick or wood piers.
- Porches: Typically partial-width set within the interior angle of the L-plan. Often feature decorative wood detailing in the Queen Anne Style, such as turned porch posts, turned balusters, and spindle friezes. Mid-twentieth century examples may employ Minimal Traditional Style detailing.
- Roofs: Originally usually metal shingle, corrugated metal, or standing seam metal. Often feature decorative wood detailing in the Queen Anne Style, such as bargeboards.
- Windows: Double-hung wood-sash, often with a two-over-two or four-over-four configuration. Often feature projecting bay windows or dormer windows.
- Doors: Typically paneled wood with glazing.
- Chimneys: Original stone or brick masonry chimney or metal stovepipe typically located at interior of floor plan or at gable ends.

Modified L-Plan Residence



Example of a modified L-plan house.

Modified L-plan houses typically were constructed after the arrival of the railroad using milled lumber with prefabricated decorative elements. The modified L-plan house is one or one-and-a-half stories. The primary difference between an L-plan house and a modified L-plan house is the roof form – while an L-plan house has a cross-gabled roof, a modified L-plan house has a side-gable or gable-on-hip roof. Also, in an L-plan house, the porch typically has a shed roof, while in a modified L-plan house, the porch is recessed under the main roof form. In Lake Charles, modified L-plan houses typically are set back with a front yard. Wood or cast iron fences may be present. Although not original,

detached garages may have been added within the district's period of significance. Original outbuildings may be present.

- Exterior Walls: Typically constructed with wood siding or wood shingles finished with paint, although occasionally brick or stone.
- Foundation: Pier and beam, typically with brick or wood piers.
- Porches: Typically partial-width set within the interior angle of the L-plan. Wraparound porches common. Often feature decorative wood detailing in the Queen Anne Style, such as turned porch posts, turned balusters, and spindle friezes. Mid-twentieth century examples may employ Minimal Traditional Style detailing.
- Roofs: Typically gable-on-hip, gable-on-pyramidal, or side-gable. Originally usually metal shingle, corrugated metal, or standing seam metal. Often feature decorative wood detailing in the Queen Anne Style, such as bargeboards.
- Windows: Double-hung wood-sash, often with a two-over-two or four-over-four configuration. Often feature projecting bay windows or dormer windows.
- Doors: Typically paneled wood with glazing.
- Chimneys: Original stone or brick masonry chimney or metal stovepipe typically located at interior of floor plan.

Center Passage Residence



Example of a center passage residence.

The front façade of a central passage residence is generally symmetrical, with the entrance located at the center. This house form is one-, two- or two-and-a-half stories in height, featuring a floor plan with a central entry hall on the ground floor, leading to a central stair. These houses usually are set back with a front yard. Concrete sidewalks or driveway runners may be present. A detached garage and/or a *porte cochere* may be associated with the main house.

- Exterior Walls: Typically brick masonry, but sometimes constructed of milled lumber with wood siding finished with paint.
- Foundations: Pier and beam, typically with brick piers.
- Porches: Either partial-width or full-width, with a projecting front-gabled, flat, or shed roof form. Porch floors may be wood or concrete. Often feature Classical Revival Style, Tudor Revival Style, Spanish Colonial Revival Style, Mission Revival Style, Prairie Style, or Craftsman Style porch supports and detailing.
- Roofs: Typically low-pitched gabled, hipped or pyramidal in form. Originally usually standing seam metal or asphalt or asbestos shingle. Dormer windows may be present.
- Windows: Double-hung wood-sash, usually with a one-over-one configuration. Often feature wood screens with geometric detailing on the upper sash with Craftsman Style or Prairie Style motifs.
- Doors: Located at the center of the front façade. Typically paneled wood with glazing.
- Chimneys: Typically brick masonry chimney located at side façade.

Shotgun Residence



Example of shotgun residence.

These houses typically are one story in height, one room wide and two or more rooms deep. They have front-gabled or hipped roof forms. The narrow gable end faces the street and typically contains a single entryway and window. Each room is placed behind the other in single file, with no hallway. The roof ridge is perpendicular to the street. Historic additions to the rear of the original structure are common. Because they often predate the surrounding construction, they may be set further back or closer to the street than surrounding, later buildings. Outbuildings or small-scale structures may be present. Although not original, detached garages may have been added within the district's period of significance.

- Exterior Walls: May be constructed with wood (often board-and-batten), stone, or brick. Surface may be finished with paint or stucco, or may be unfinished.
- Foundation: Pier and beam, typically with brick or wood piers.
- Porches: Typically full-width with a shed roof and a wood porch floor.
- Roofs: Originally usually wood shingle, metal shingle, corrugated metal, or standing seam metal.
- Windows: Double-hung wood-sash, often with a two-over-two or four-over-four configuration.
- Doors: Typically wood without glazing.
- Chimneys: Original stone or brick masonry chimneys may be located at exterior walls.

Bungalow Residence



A one-story Craftsman Style bungalow residence.

Bungalows typically were constructed from ca. 1915 to ca. 1945. Bungalow plans were standardized, often distributed through lumber companies. Bungalows are usually one-story in height but are sometimes one-and-a-half or two-stories. Floor plans usually are organized with the living room, dining room, and kitchen aligned on one side of the house, and the bedrooms aligned on the other side, so that corridor space is minimized. Bungalows typically are set back from the street, with a front yard. Concrete sidewalks or driveway runners may be present. Because bungalows often were constructed after the advent of the automobile, a detached garage may be associated with the house, and/or a *porte cochere* attached to a side façade of the house.

- Exterior Walls: Typically constructed of milled lumber with wood siding finished with paint, but sometimes constructed of brick or stone masonry.
- Foundation: Typically pier and beam with brick piers, but sometimes concrete stem wall and footing.
- Porches: Typically partial-width with a front-gabled roof form and wood or concrete porch floor. Often feature Craftsman Style tapered porch piers, sometimes on wood or stone bases. However, sometimes feature Classical Revival Style, Tudor Revival Style, Spanish Colonial Revival Style, or Mission Revival Style porch supports and detailing.
- Roofs: Roof form typically front- or side-gabled, with deep eaves. Originally usually standing seam metal or asphalt or asbestos shingle. Often detailed with exposed rafter ends.
- Windows: Double-hung wood-sash, usually with a one-over-one configuration. Often feature wood screens with geometric detailing on the upper sash with Craftsman Style or Prairie Style motifs. Eyebrow gable windows may be present.
- Doors: Typically paneled wood with geometric pattern of lites in the upper portion.
- Chimneys: When present, typically brick masonry and located at side façade.

Ranch House



Example of a Ranch house.

Ranch houses were constructed nationwide beginning ca. 1940, continuing with the post-World War II housing boom. Ranch houses were constructed using prefabricated building materials, and often standardized plans were repeated within subdivisions. The Ranch house form is nearly always one-story. The footprint may be rectangular, L-Plan, rambling and irregular, or split-level. The interior floor plan of a Ranch house is open, with free-flowing living, dining, and kitchen spaces, many of which open out onto outdoor spaces such as courtyards or patios. Ranch houses typically lack applied architectural ornament, and instead feature details integral to the design of the house that are influenced by the Ranch Style, Modern Style, or Contemporary Style. Garages or carports are integral to the overall form and design of the Ranch house, and most examples include an attached carport or a one- or two-car garage.

- Exterior Walls: Sometimes constructed of milled lumber with wood siding finished with paint or asbestos shingle siding, and sometimes brick or stone masonry. Masonry units often have a long, thin, rectangular shape, such as Roman brick or flagstone.
- Foundations: Typically concrete slab.
- Porches: Typically partial-width and recessed under the main roof form. Often feature geometric wood or decorative wrought iron porch supports, or porch roof may be cantilevered. Porch floors typically concrete. Brick or stone planters sometimes integrated into porch design.
- Roofs: Roof typically low-sloped and hipped or side-gabled, sometimes with deep eaves. Originally usually asphalt or asbestos shingle.
- Windows: Often wood or metal casement; metal awning or jalousie; or double-hung metal sash. Often feature large, fixed-pane picture windows.
- Doors: Typically wood, often with geometric glazing or relief patterns.
- Chimneys: When present, often wide, constructed of Roman brick or flagstone masonry, and set asymmetrically on front façade.

Detached Garage



Example of a detached garage.



Example of a porte cochere.

Detached garages typically are one-story in height with a rectangular footprint and a single, open interior space. Garages typically are sited at the rear of the lot, behind the main house.

Some historic residences in the districts have *porte cocheres* in lieu of detached garages.

- Exterior Walls: Most commonly wood siding or board-and-batten, but may be brick or stone.
- Foundations: Usually poured concrete slab, but some examples have no foundation, only a dirt floor.
- Porches: Seldom include porches.
- Roofs: Roof form most often front-gabled, but may be side-gabled or hipped. Roofing material usually matches associated main house.
- Windows: Usually limited to side façades. Window materials and configuration typically match associated main house.
- Doors: In garages, overhead rolling doors are common, but original hasp-hung doors or hinged doors may be present.
- Chimneys: Seldom include chimneys.

One-Part Commercial Block



A grouping of Prairie Style one-part commercial block buildings. Note the storefronts, transom windows, and parapets.

One-part commercial block buildings are one-story, box-like buildings typically set forward flush with the lot boundary. These buildings are designed to interact with pedestrian-related activity. The storefront typically has a three-part configuration, with large plate-glass display windows in the outer bays and a centrally placed doorway; however, variations of this pattern do exist. The primary entrance is sometimes placed within a recessed central bay, which has a second set of display windows at angles to the doorway.

- **Exterior Walls:** Most commonly brick, stone, or concrete masonry. Walls may include detailing such as corbelling, texture, or applied tile at the entrance. Detailing may reflect the Classical Revival, Romanesque Revival, Prairie, Spanish Eclectic, Art Deco, or Moderne Style.
- **Foundations:** Usually poured concrete slab.
- **Roofs:** Typically flat, with masonry parapet. Parapets often detailed with stone coping or corbelling at the cornice. Parapets may be stepped or molded. Elaborate wood or cast iron cornices may be present.
- **Storefronts:** The majority of the front façade typically is occupied by a storefront assembly of windows and doors. Glazing may be set in a wood or metal frame, depending upon date of construction. Storefronts often include a row of transom windows over the doors and display windows.
- **Canopies:** Canopies often extend the full width of the building. Canopies may be constructed of wood or metal and may be supported by suspension bars, suspension cables, wood or metal posts, wood or metal brackets, or cantilevering. Canopies do not conceal historic transoms or storefront windows.
- **Windows:** Other than the storefront, windows are minimal. If present on side or rear façades, windows may be double-hung, casement, or fixed.
- **Doors:** Other than the storefront, doors are minimal. If present on side or rear façades, doors may be wood or metal. These secondary doors typically lack architectural detail.

Two-Part Commercial Block



Two-part commercial block buildings in the Italianate (left) and Romanesque Revival Styles (center and right). Note storefronts and parapets.

Two-part commercial block buildings are at least two stories in height. The ground floor typically houses retail space or a reception area that is open and accessible to the public from the sidewalk, while the upper floor(s) include more private office or residential spaces. The distinction between these two levels is typically illustrated on the front façade by a horizontal element such as a stringcourse or canopy. The first floor typically features a storefront with large windows, along with a secondary entrance leading to the upper floor(s). The upper floors typically have more solid walls with smaller windows.

- **Exterior Walls:** Most commonly brick, stone, or concrete masonry. Walls may include detailing such as corbelling, texture, or applied tile at the entrance. Detailing may reflect the Classical Revival, Romanesque Revival, Prairie, Spanish Eclectic, Art Deco, or Moderne Style.
- **Foundations:** Usually poured concrete slab.
- **Roofs:** Typically flat, with masonry parapet. Parapets often detailed with stone coping or corbelling at the cornice. Parapets may be stepped or molded. Elaborate wood or cast iron cornices may be present.
- **Storefronts:** The majority of the front façade typically is occupied by a storefront assembly of windows and doors. Glazing may be set in a wood or metal frame, depending upon date of construction. Storefronts often include a row of transoms over doors and windows.
- **Canopies:** Canopies often extend the full width of the building. Canopies may be constructed of wood or metal and may be supported by suspension bars, suspension cables, wood or metal posts, wood or metal brackets, or cantilevering. Canopies do not conceal historic transoms or storefront windows.
- **Windows:** Windows on upper floors or secondary façades may be double-hung, casement, or fixed. At upper floors, windows often feature stone lintels and sills and/or decorative surrounds.
- **Doors:** In addition to the storefront, two-part commercial block buildings include a separate door at the ground floor that leads to the upper floor(s). This door may be wood or metal and often is enhanced by sidelights, a transom, a decorative surround, and/or a decorative stoop.

Temple-Front



Example of a Temple-front governmental building. Note pedimented entry porches with columns.

A Temple-front building is a commercial, institutional, educational, or religious edifice with columns, pediments, and other physical elements that reflect Classical Greek or Roman architectural traditions used in the Greek Revival, Colonial Revival, or Classical Revival styles. Temple-front buildings are always symmetrical. Although the massing of a Temple-front building often is box-like, it also may take on a more complex mass. The entrance is often set within a recessed middle bay that is framed by large pilasters or freestanding columns. The façade may also include a pediment or entablature with dentils, a cornice, and other details. A signature trait is a symmetrically composed front façade.

- Exterior Walls: Most commonly brick, stone, or concrete masonry. Walls may include detailing such as quoins, string courses, or belt courses. Detailing typically influenced by the Greek Revival, Colonial Revival, or Classical Revival Style.
- Foundations: Usually poured concrete slab or pier-and-beam.
- Roofs: Typically flat, with masonry parapet. Elaborate stone or cast concrete cornices are often present.
- Storefronts: If present, storefronts typically are recessed behind the colonnaded temple front. Storefront assemblies may be metal or wood. Non-commercial temple-front buildings often do not include storefronts.
- Canopies: Canopies seldom are present on temple-front buildings.
- Windows: Windows typically are located behind or between the columns or pilasters that compose the temple-front. Windows may be double-hung or casement and often feature stone lintels and sills and/or decorative surrounds.
- Doors: Temple-front buildings typically feature grand double-doors, enhanced by transoms, sidelights, and decorative surrounds.

Enframed Window Wall



Example of a Modern enframed window wall building. Note storefront and projecting elements framing the façade.

Enframed window wall buildings have a rectangular façade with a large center section enframed by an often continuous border.

- Exterior Walls: Most commonly brick, stone, or concrete masonry. Most commonly feature Modern architectural detailing, but may have period stylistic detailing.
- Foundations: Usually poured concrete slab.
- Roofs: Typically flat.
- Storefronts: The majority of the front façade typically is occupied by a storefront assembly of windows and doors. Glazing may be set in a wood or metal frame, depending upon date of construction. Storefronts often include a row of transoms over doors and windows.
- Canopies: Canopies often cover the full width of the building. Canopies may be constructed of wood or metal and may be supported by suspension bars, suspension cables, wood or metal posts, wood or metal brackets, or cantilevering.
- Windows: Windows on upper floors or secondary façades may be double-hung, casement, or fixed. At upper floors, windows often feature stone lintels and sills and/or decorative surrounds.
- Doors: The door may be wood or metal and often is enhanced by sidelights, a transom, a decorative surround, and/or a decorative stoop.

Central Block with Wings



Example of a Classical Revival central block with wings.

The central block with wings is often applied to institutional buildings or grand commercial buildings, such as banks. The building is massed with a main central core and projecting wings on one or both sides. The central core may be taller than the wings, and/or its front façade may project forward. Most examples of the central block with wings range in height from one-story to four-stories.

- Exterior Walls: Most commonly brick, stone, or concrete masonry. Walls may include detailing such as corbelling, texture, or applied tile at the entrance. Detailing may reflect the Classical Revival, Romanesque Revival, Italianate, Prairie, Spanish Eclectic, or Art Deco Style.
- Foundations: Usually poured concrete slab.
- Roofs: May be side-gabled, hipped, or flat. Side-gabled or flat roofs often feature exposed rafters or brackets influenced by the Classical Revival, Italianate, or Spanish Eclectic Style. Elaborate wood, cast iron, or stone cornices may be present.
- Storefronts: Many examples lack storefronts. Storefronts, if present, typically are limited to the central core. Glazing may be set in a wood or metal frame, depending upon date of construction. Storefronts often include a row of transom windows over the doors.
- Canopies: Many examples lack canopies. Canopies, if present, typically are limited to the central core. Canopies may be constructed of wood, metal, or concrete, and may be supported by suspension bars, suspension cables, wood or metal posts, wood or metal brackets, or cantilevering.
- Windows: Windows may be double-hung, casement, or fixed. Windows often feature stone lintels and sills and/or decorative surrounds.
- Doors: Double-doors are typical. Doors may be wood or metal, often with glazing. Transoms, sidelights, and elaborate stone door surrounds are common.

Two-Part Vertical Commercial Block



An Art Deco Style two-part vertical commercial block.

The two-part vertical commercial block building is at least three stories in height, with vertical proportions. The front façade is divided into two distinct zones: the ground floor and the shaft above. A horizontal element such as belt course or canopy separates these two zones. The ground floor often is more open, featuring transparent storefront windows and doors, while the upper floors are more private, with smaller windows. Ornate cornices and parapets along the roofline are character-defining features.

- Exterior Walls: Most commonly brick, stone, or concrete masonry. Walls may include detailing such as corbelling, texture, or applied tile at the entrance. Detailing may reflect the Classical Revival, Romanesque Revival, Prairie, Spanish Eclectic, or Art Deco Style.
- Foundations: Usually poured concrete slab.
- Roofs: Typically flat, with masonry parapet. Parapets often detailed with stone coping or corbelling at the cornice. Parapets may be stepped or molded. Elaborate wood or cast iron cornices may be present.
- Storefronts: The majority of the front façade typically is occupied by a storefront assembly of windows and doors. Glazing may be set in a wood or metal frame, depending upon date of construction. Storefronts often include a row of transom windows over the doors.
- Canopies: Canopies often cover the full width of the building. Canopies may be constructed of wood, metal, or concrete, and may be supported by suspension bars, suspension cables, wood or metal posts, wood or metal brackets, or cantilevering.
- Windows: Windows on upper floors or secondary façades may be double-hung, casement, or fixed. At upper floors, windows often feature stone lintels and sills and/or decorative surrounds.
- Doors: In addition to the storefront, two-part vertical commercial block buildings may include a door at the ground floor that leads to the upper stories. This door may be wood or metal and often is enhanced by sidelights, a transom, a decorative surround, and/or a decorative stoop.

Three-Part Vertical Commercial Block



Example of a Renaissance Revival Style three-part commercial block.

The three-part vertical commercial block building is at least four stories in height, with vertical proportions. The front façade is divided into three distinct zones that resemble the parts of a classical column: the ground floor resembles the base, the middle floors resemble the shaft, and the uppermost floor resembles the capital. Horizontal elements such as belt courses or canopies separate these three zones. The ground floor often is more open, featuring transparent storefront windows and doors, while the upper floors are more private, with smaller windows. The uppermost floors include dramatic cornices and bold architectural

detailing that is large in scale so that it may be seen from the street. Ornate cornices and parapets are common.

- Exterior Walls: Most commonly brick, stone, or concrete masonry. Walls may include detailing such as corbelling, texture, or applied tile at the entrance. Detailing may reflect the Classical Revival, Romanesque Revival, Prairie, Spanish Eclectic, or Art Deco Style.
- Foundations: Usually poured concrete slab.
- Roofs: Typically flat, with masonry parapet. Parapets often detailed with stone coping or corbelling at the cornice. Parapets may be stepped or molded. Elaborate wood, cast iron, or stone cornices may be present.
- Storefronts: The majority of the front façade typically is occupied by a storefront assembly of windows and doors. Glazing may be set in a wood or metal frame, depending upon date of construction. Storefronts often include a row of transom windows over the doors.
- Canopies: Canopies often cover the full width of the building. Canopies may be constructed of wood, metal, or concrete, and may be supported by suspension bars, suspension cables, wood or metal posts, wood or metal brackets, or cantilevering.
- Windows: Windows on upper floors or secondary façades may be double-hung, casement, or fixed. At upper floors, windows often feature stone lintels and sills and/or decorative surrounds.
- Doors: In addition to the storefront, three-part vertical commercial block buildings may include a door at the ground floor that leads to the upper stories. Doors may be wood or metal with sidelights, a transom, a decorative surround, and/or a decorative stoop.

Commercial Block



An example of a utilitarian commercial block building.

The commercial block building has no major architectural features and can range from one to a few stories tall. A building of this form is typically a large commercial or industrial-use building with a utilitarian appearance and lacks any type of storefront or service bay. The interior might be divided into office space and open space for storage or work areas

- Exterior Walls: Can be from a variety of materials, including brick, concrete block, concrete, or stucco panels.
- Foundations: Usually poured concrete slab.
- Roofs: Roofs are typically flat.
- Windows: Are usually metal fixed or casement. They are simple and functional.
- Doors: Usually simple and functional metal doors.

Service Station/Service Bay Business



Example of a Tudor Revival service station.

Buildings historically designed to serve as gas stations and service stations take on a variety of forms and physical features. All, however, are designed to accommodate automobile traffic, typically featuring paved parking lots or driveways and large garage door openings. Many include large canopies that historically sheltered gas pumps. Other character-defining features that may be present include projecting or freestanding metal signage or gas pumps. Service bay businesses generally house businesses that utilized a service or delivery vehicle of some type—the bays are not used for vehicle repair.

- Exterior Walls: Most commonly brick, stone, or concrete masonry, sometimes veneered with stucco or ceramic tile.
- Foundations: Usually poured concrete slab.
- Roofs: Most often flat, but sometimes gabled, hipped, or mansard. Decorative parapets sometimes present.
- Storefronts: Storefront assemblies are typically modest, set in a metal frame.
- Canopies: Canopies often are large and dramatic, featuring flat, shed, gabled, vaulted, or even airplane roof forms. Canopies may be supported by metal columns, masonry pilasters, or cantilevered from the associated building.
- Windows: Windows typically are small and may be double-hung, casement, or fixed.
- Doors: In addition to storefront doors, gas stations typically include large overhead doors that allow automobiles to enter the building.

Warehouse



Example of a warehouse. Note loading bays.

Warehouse buildings historically were designed to receive, store, and distribute goods. Therefore, these buildings are integrally related to the transportation networks that adjoin them. Warehouses often are located near railroad tracks. They usually include loading docks with large door openings that accommodate trucks or train cars. Additionally, warehouses typically include minimal windows, in order to protect the goods stored within. Historic machinery, such as elevators or conveyor belts, may be extant within warehouses.

- Exterior Walls: Most commonly brick, stone, or concrete masonry, sometimes veneered with stucco.
- Foundations: Usually poured concrete slab.
- Roofs: Typically flat, with masonry parapet. Decorative parapets sometimes present.
- Storefronts: Storefront assemblies are typically modest, set in a metal frame.
- Canopies: Canopies typically are designed to protect loading docks or entrances. To allow open access, canopies typically are suspended with metal bars or cables or cantilevered. Canopies may be wood, metal, or concrete.
- Windows: If present, windows typically are small and may be double-hung, casement, or fixed.
- Doors: In addition to storefront doors, warehouses typically include large overhead doors that access loading docks.

Religious Building Forms



Example of a Catholic church with a Latin cross plan and bell tower.

Several types of ecclesiastical buildings of different faith denominations are located in the Charlestown Cultural District. Churches or synagogues generally have a rectangular plan or a cruciform plan. Christian churches usually have a bell tower (or towers) at the primary or side façades. Catholic churches may exhibit a Latin cross plan where one intersecting arm of the “cross” (usually the wing with the primary entrance facing the street) is longer than the others. They exhibit characteristics of high architectural styles ranging from Romanesque Revival and Gothic Revival to Romanesque.

- Exterior Walls: Most commonly brick, stone, or concrete masonry. Walls may include detailing such as quoins, string courses, or belt courses. Detailing typically influenced by the Romanesque Revival, Gothic Revival, or Classical Revival/Neoclassical Style. Newer churches may be built with Modern stylistic details.
- Foundations: Usually poured concrete slab or raised basement.
- Roofs: Typically gabled, sometimes with masonry parapet. Elaborate stone or cast concrete cornices are often present. Bell towers may also be present.
- Windows: Windows may be double-hung, casement, or fixed and often feature stone lintels and sills and/or decorative surrounds.
- Doors: Religious buildings typically feature grand double-doors, enhanced by transoms, sidelights, and decorative surrounds.

ARCHITECTURAL STYLES

Architectural styles may be applied to any number of different building forms. For instance, architectural details influenced by the Classical Revival Style may be applied to a single-family house, a multi-story commercial building, a warehouse, or even a gas station. Unlike building form classifications, architectural styles are seldom related to a building's use. Instead, they tend to be related to the building's era of construction and popular regional trends. Within the Charlestown Cultural District, common architectural styles include the following:

- National Folk/Vernacular
- Gothic Revival
- Colonial Revival
- Romanesque Revival
- Renaissance Revival
- Queen Anne
- Classical Revival/Neoclassical
- Italianate
- Tudor Revival
- Spanish Eclectic
- French Eclectic
- Craftsman
- Prairie
- Art Deco
- Moderne
- Ranch
- Modern
- Contemporary

Not all historic resources exemplify a particular architectural style. Some are purely utilitarian and use no style at all. Others eclectically combine several styles (especially early twentieth century Revival styles). Architectural styles can be integral to the

form of the building and related to the building form, or can be displayed through decorative ornament applied to a building. Some typical character-defining features of each architectural style are listed. A resource does not need to display all of the listed character-defining features to be considered a good example of a style; however, when these character-defining features are intact, they must be preserved in order to preserve the overall character of the architectural style. Resources also may exhibit different stylistic elements due to changes over time. If these changes occurred during the historic district's period of significance, such changes should be respected and possibly retained during restoration or rehabilitation projects.

Architectural styles can be integral to the form of the building or manifested in decorative ornament applied to a building. While building forms often are clustered together, architectural styles may be very eclectic within a grouping. Architectural styles often vary depending on date of construction or historic use. Some architectural styles were very popular for a confined period of time but then declined in popularity, but because many architectural styles—especially “Revival” styles—have their roots in earlier architectural styles, they are used throughout the historic period rather than in one confined era. Standard classifications for architectural styles are set forth by the National Park Service in Bulletin No. 16a, *How to Complete the National Register Registration Form*, and are derived from seminal texts in American Architectural History such as *American Architecture Since 1780: A Guide to Architectural Styles* by Marcus Whiffen; *Identifying American Architecture* by John J. G. Blumenson; *What Style Is It?* by John Poppeliers, S. Allen Chambers, and Nancy B. Schwartz; and *A Field Guide to American Houses* by Virginia and Lee McAlester. (See *Appendix H: Additional Resources*.)

An additional extremely useful resource on traditional building and neighborhood patterns is the *Louisiana Speaks: Pattern Book* by Urban Design Associates. Its section on “Architectural Patterns” places the architectural styles prevalent in the Charlestown Cultural District in the following categories:

- Louisiana Vernacular—National Folk, Colonial Revival
- Louisiana Classical—Classical Revival/Neoclassical
- Louisiana Victorian—Gothic Revival, Renaissance Revival, Romanesque Revival, Queen Anne
- Louisiana Arts & Crafts—Craftsman, Prairie
- Louisiana Modern—Ranch

Colonial Revival architecture encompasses Acadian- and Creole-influenced architecture considered in the “Louisiana Vernacular” category. The pattern book does not feature examples of Italianate, Tudor Revival or Spanish Eclectic residences which fall under the umbrella of late nineteenth to early twentieth century eclectic architectural styles. In the Charlestown Cultural District, the Art Deco Moderne, Modern, Contemporary styles are used for commercial, institutional, or governmental buildings which are not discussed in *Louisiana Speaks*.

National Folk/Vernacular



Example of a Hall-and-Parlor National Folk residence.

- Building Forms: Residential properties with L-plan, modified-L, pyramidal-roof-square-plan, or hipped-roof-square-plan.
- Exterior Walls: Usually wood siding or wood shingle.
- Foundations: Often screened with skirting of wood, pressed metal, brick, or stone.
- Porches: Feature simple woodwork, such as turned porch supports or balusters. Porch floors often wood and porch ceilings often bead board. Decorative detail, if present, typically prefabricated.
- Roofs: Cross-gabled, gable-on-hip, hipped, or pyramidal.
- Storefronts: Seldom present on National Folk Style buildings.
- Canopies: Seldom present on National Folk Style buildings.
- Windows: Typically double-hung wood sash.
- Doors: Typically wood, sometimes with glazing, transoms, and/or sidelights.
- Chimneys: Brick or stone, if extant. Sometimes metal stovepipe substitutes for chimney.

Gothic Revival



Example of a Gothic Revival church.

- **Building Forms:** On residential or institutional examples, bungalow, L-plan, or irregular. On commercial or institutional examples, one-part commercial block, two-part commercial block, two-part vertical block, or three-part vertical block.
- **Exterior Walls:** Usually brick or stone masonry in varying colors, patterns, and textures, with exaggerated mortar joints, sometimes seeping. Sometimes stucco.
- **Foundations:** Usually skirted with brick or stone.
- **Porches:** If present, typically include Gothic arches supported by brick or stone piers. Often feature heavy hardware, such as handrails and light fixtures.
- **Roofs:** On residential or institutional examples, typically front-gabled or cross-gabled with steep pitch. On commercial examples, typically flat. Parapets often include stone coping and may include crenellations.
- **Storefronts:** May be present on commercial examples, typically wood sash.
- **Canopies:** Commercial examples may lack canopies. When present, canopies typically may be wood or metal, supported by brackets or columns, or suspended by bars or cables.
- **Windows:** Usually double-hung wood sash or casement. Window openings often feature Gothic arches. Leaded glass in a lattice pattern often present. Brick or stone lintels and sills common.
- **Doors:** Often feature heavy cast-iron hardware. Stone door surrounds common.
- **Chimneys:** Prominent brick chimneys, often on the front façade are a character-defining feature on residential examples. Sometimes feature chimney caps with corbelling or crenellations. Seldom present on non-residential examples.

Colonial Revival



Example of a Colonial Revival two-story, center passage residence. Note monumental porch and columns and segmental arched door surround.

- **Building Forms:** On residential or institutional examples, American four-square, two-story center-passage, Cape Cod, or bungalow. On commercial or institutional examples, one-part commercial block, two-part commercial block, temple front, two-part vertical block, or three-part vertical block.
- **Exterior walls:** Typically brick, but may be wood siding.
- **Foundations:** Typically pier and beam skirted with brick.
- **Porches:** Residential examples often include partial-width or full-width porches, with front-gabled or flat roof supported by wood or stone columns. Residential examples may include a front-gabled or arched portico over the main entrance, supported by brackets.
- **Roofs:** On residential or institutional examples, typically side-gabled or gambrel. Wood cornice and enclosed eaves, often painted white. Slate shingles sometimes present. Dormer windows common on residential examples. On commercial examples, typically flat.
- **Storefronts:** On commercial examples, typically wood sash, cast iron, or aluminum with sidelights and transoms.
- **Canopies:** Commercial examples may lack canopies, especially if temple front. When present, canopies typically may be wood or metal, supported by brackets or columns, or suspended by bars or cables.
- **Windows:** Typically double-hung wood sash, painted white. Often flanked by wood shutters.
- **Doors:** Typically wood, sometimes topped with fanlights. Commonly include sidelights, ornate door surrounds, pediments, etc.
- **Chimneys:** Character-defining feature on residential examples, typically brick.

Romanesque Revival



Example of a two-part commercial block in the Romanesque Revival Style.

- Building Forms: On residential or institutional examples, center-passage, L-plan, or two-story center-passage plan. On commercial examples, one-part commercial block, two-part commercial block, two-part vertical block, or three-part vertical block.
- Exterior Walls: Brick and/or stone masonry, often with rusticated texture. Figural stone carving may adorn wall surfaces.
- Foundations: Often screened with brick or stone.
- Porches: Found on some residential examples. Portico or porch with round-arched entries; may be supported by short-tapered stone columns or piers or recessed into façade.
- Roofs: On residential or institutional examples, flat, cross-gabled, or hipped. On commercial examples, typically flat.
- Storefronts: On commercial examples, typically wood sash or cast iron with sidelights and transoms.
- Canopies: Commercial examples may lack canopies, but when present, canopies typically are wood supported by brackets or suspended by bars or cables.
- Windows: Typically double-hung wood sash. Window openings often arched.
- Doors: Typically wood, sometimes with glazing, transoms, and/or sidelights.
- Chimneys: Brick or stone, if extant.

Renaissance Revival



Example of a Renaissance Revival Style three-part vertical block.

- Building Forms: One-part commercial block, two-part commercial block, two-part vertical block, temple front, or three-part vertical block with a symmetrical facade.
- Exterior Walls: Brick or stone masonry. Accentuated belt/string courses. Stone quoins common at the corners of masonry examples.
- Foundations: Typically skirted with brick or stone. Examples may feature rusticated ground floor and stone quoins.
- Porches: Arcades at ground level, often with a loggia.
- Roofs: Flat with decorative or wide, overhanging cornices. Cornices feature classical detailing and brackets.
- Storefronts: Typical on commercial examples, may be wood or metal sash.
- Canopies: Typical on commercial examples, may be wood or metal, supported by brackets or suspended by bars or cables. Canopy roof form typically flat.
- Windows: May feature Roman or segmental arch openings. Wood casement or double-hung wood sash windows.
- Doors: May feature Roman or segmental arch openings. Typically wood, sometimes with glazing, transoms, and/or sidelights.
- Chimneys: Not present on commercial examples.

Queen Anne



Example of an irregular-plan Queen Anne Style residence.

- **Building Forms:** Residential or institutional properties, L-plan, modified-L, or irregular. Less commonly applied to commercial properties, but may be one-part commercial block, two-part commercial block, two-part vertical block, or three-part vertical block.
- **Exterior Walls:** Usually wood siding or wood shingle, but sometimes brick or stone. Often with a variation of materials, colors, and textures.
- **Foundations:** Often screened with skirting of wood, pressed metal, brick, or stone.
- **Porches:** A character-defining element on residential examples. Feature decorative woodwork, such as turned balusters and spindle friezes. Wraparound porches common. Porch floors often wood and porch ceilings often bead board.
- **Roofs:** On residential or institutional examples, cross-gabled, gable-on-hip, hipped, or pyramidal, often with dormers. On commercial examples, typically flat, but sometimes cross-gabled, gable-on-hip, hipped, or pyramidal.
- **Storefronts:** On commercial examples, typically wood sash or cast iron with sidelights and transoms. Colored or etched glass sometimes present.
- **Canopies:** On commercial examples, typically wood supported by brackets or suspended by bars or cables.
- **Windows:** Typically double-hung wood sash. Bay windows common character-defining feature.
- **Doors:** Typically wood, often with glazing, transoms, and/or sidelights.
- **Chimneys:** Often found on residential examples. Commonly brick or stone, often with decorative tapestry brick or corbelling. Sometimes metal stovepipe substitutes for chimney.

Classical Revival/Neoclassical



Example of a foursquare Classical Revival house with a rear addition. Note the porch with monumental columns.



This is a Classical Revival Style commercial building with a temple front form.

- Building Forms: On residential properties, center-passage, two-story center-passage plan, or irregular.
- Exterior Walls: Wood siding, brick, or stone masonry.
- Foundations: Typically skirted with brick or stone.
- Porches: A character-defining feature on residential, institutional, or commercial examples. Full-width or partial-width colonnade or arcade, supported by columns or pilasters with decorative capitals. Porch roof may be flat or front-gabled with a pediment.
- Roofs: On residential or institutional examples, flat, side-gabled, front-gabled, or hipped. Slate shingles sometimes present. On commercial examples, typically flat. May feature roof cupola.
- Storefronts: On commercial examples, typically wood sash, cast iron, or aluminum with sidelights and transoms.
- Canopies: Commercial examples may lack canopies, especially if temple front. When present, canopies typically may be wood or metal, supported by brackets or columns, or suspended by bars or cables.
- Windows: Typically double-hung wood sash.
- Doors: Typically wood, sometimes with glazing, transoms, and/or sidelights.
- Chimneys: Brick or stone if extant. Not present on commercial examples

Italianate



The Old Lake Charles City Hall is a central block with wings in the Italianate Style.

- **Building Forms:** On residential or institutional examples, center-passage, L-plan, two-story center-passage plan, or irregular. On commercial examples, one-part commercial block, two-part commercial block, two-part vertical block, or three-part vertical block.
- **Exterior Walls:** Wood siding, brick, or stone masonry. Stone quoins common at the corners of masonry examples.
- **Foundations:** On residential examples, often screened with wood, pressed metal, brick, or stone. On commercial examples, typically concrete slab.
- **Porches:** Residential examples often lack porches. Entrance may be protected by an awning supported by brackets, or a small portico supported by columns.
- **Roofs:** On residential or institutional examples, flat, cross-gabled, or hipped. On commercial examples, typically flat. Bracketed eaves and ornate, molded cornices typical. Cornices may be wood, stone, or wrought iron.
- **Storefronts:** On commercial examples, typically wood sash or cast iron with sidelights and transoms.
- **Canopies:** Commercial examples may lack canopies, but when present, canopies typically are wood supported by brackets or suspended by bars or cables.
- **Windows:** Typically double-hung wood sash. Segmental-arched windows with ornate window surrounds common.
- **Doors:** Typically wood, sometimes with glazing, transoms, and/or sidelights.
- **Chimneys:** Brick or stone, if extant.

Tudor Revival



Example of a Tudor Revival residence. Note the prominent chimney and steep roof lines.

- Building Forms: On residential or institutional examples, bungalow, L-plan, or irregular.
- Exterior Walls: Usually brick masonry in varying colors, patterns, and textures, with exaggerated mortar joints, sometimes seeping. Sometimes stone or stucco. Faux half-timbering often adorning gable-ends. Wing walls or buttresses sometimes accenting front façade.
- Foundations: Usually skirted with brick.
- Porches: If present, sometimes include low-sloped Gothic arches supported by brick piers.
- Roofs: Gable-on-hip or front gabled. Often complex. Eaves sometimes swept.
- Storefronts: Seldom present on Tudor Revival Style buildings.
- Canopies: Seldom present on Tudor Revival Style buildings.
- Windows: Usually double-hung wood sash. Window openings sometimes feature low-sloped Gothic arches. Sometimes feature picture windows with leaded glass in a lattice pattern.
- Doors: Round-arched wood doors with small lites.
- Chimneys: Prominent brick chimneys, often on front façade, are a character-defining feature on residential examples. Sometimes feature chimney caps with corbelling or crenellations.

Spanish Eclectic



Example of a Spanish Eclectic central passage plan house. Note stucco walls with curved end walls and clay tile roof.

- **Building Forms**: On residential or institutional properties, L-plan, two-story center-passage, bungalow, or irregular. On commercial or institutional examples, one-part commercial block, two-part commercial block, two-part vertical block, or three-part vertical block.
- **Exterior Walls**: Stucco, sometimes with texture or molded decorative wall elements. Tile detailing common.
- **Foundations**: Typically skirted with masonry finished with stucco.
- **Porches**: Sometimes lack porches. Residential examples sometimes feature cantilevered awnings over entrance, or partial-width porches with arched openings supported by masonry piers. Often feature heavy hardware, such as handrails and light fixtures. Second story balconies or roof decks sometimes present.
- **Roofs**: Typically flat or low-sloped hipped, often covered with clay tile.
- **Storefronts**: Typical on commercial examples, may be wood or metal sash.
- **Canopies**: Typical on commercial examples, may be wood or metal, supported by brackets or suspended by bars or cables. Canopy roof form may be flat, shed, or hipped, often with clay tiles.
- **Windows**: Double-hung or casement windows, with metal or wood sash. Sometimes featuring wrought iron grates or balconies.
- **Doors**: On residential and institutional examples, typically heavy wood, sometimes with small lites. Often feature heavy hardware. Stone door surrounds common.
- **Chimneys**: Stucco, often with tile caps.

French Eclectic



Example of a French Eclectic warehouse building. Note mansard roof behind parapet façade.

- **Building Forms:** On residential or institutional properties, may be L-plan, two-story center-passage, bungalow, or irregular. On commercial or institutional examples, one-part commercial block, two-part commercial block, two-part vertical block, three-part vertical block, or central block with wings.
- **Exterior Walls:** Typically brick or stone. Stone detailing such as quoins, lintels, sills, and door surrounds common.
- **Foundations:** Typically skirted with brick or stone.
- **Porches:** Often lack porches. Entrance often recessed behind façade. May include a small projecting portico.
- **Roofs:** On residential examples, may be hipped, cross-gabled, or mansard. Dormer windows common on residential examples. On commercial or institutional examples, typically flat or mansard. Slate shingles common.
- **Storefronts:** Typical on commercial examples, may be wood or metal sash.
- **Canopies:** Typical on commercial examples, may be wood or metal, supported by brackets or suspended by bars or cables. Canopy roof form may be flat, shed, or hipped, often with clay tiles.
- **Windows:** Double-hung or casement windows, with metal or wood sash. Sometimes feature picture windows with leaded glass in a lattice pattern.
- **Doors:** On residential and institutional examples, typically heavy wood, sometimes with small lites. Often feature heavy hardware. Elaborate stone door surrounds common.
- **Chimneys:** Massive stone or brick chimneys are a character-defining feature of residential examples.

Craftsman



Example of a Craftsman Style bungalow. Note exposed rafter and tapered porch supports.

- Building Forms: On residential or institutional examples, L-plan or bungalow. Seldom applied to commercial examples.
- Exterior Walls: Typically wood siding or asbestos shingle, sometimes brick. Sometimes feature wood shingle detailing.
- Foundations: Typically skirted with wood or brick. Skirt walls sometimes battered.
- Porches: Porches are a character-defining feature. Partial-width or full-width, often with front-gabled roof, typically supported by tapered wood, brick, or stone columns but sometimes supported by metal posts.
- Roofs: Low-sloped hipped or gabled, with deep eaves, often with exposed rafter ends.
- Windows: Typically double-hung wood sash, often with wood screens with geometric detail.
- Storefronts: Seldom present on Craftsman Style buildings.
- Canopies: Seldom present on Craftsman Style buildings.
- Doors: Typically wood with glazing, sometimes with transoms and sidelights.
- Chimneys: Brick, sometimes with corbelling or stone coping.

Prairie



Example of a Prairie Style two-part commercial block. Note geometric detailing and storefronts.

- **Building Forms:** On residential properties, typically L-plan, American four-square, two-story center-passage plan, and bungalow. On commercial or institutional examples, one-part commercial block, two-part commercial block, two-part vertical block, or three-part vertical block.
- **Exterior Walls:** Brick, sometimes Roman brick, sometimes with string course for horizontal emphasis. Stone or tile detailing in geometric pattern sometimes present.
- **Foundations:** Typically skirted with brick.
- **Porches:** Supported by brick piers with stone coping and detailing.
- **Roofs:** On residential examples, low-sloped hipped with deep, enclosed eaves. On commercial and institutional examples, typically flat with geometric detailing at the cornice.
- **Storefronts:** Typical on commercial examples, may be wood or metal sash.
- **Canopies:** Typical on commercial examples, may be wood or metal, supported by brackets or suspended by bars or cables. Canopy roof form typically flat.
- **Windows:** Typically double-hung wood sash, often with wood screens with geometric detail. Art glass sometimes present.
- **Doors:** Typically wood with glazing, sometimes with transoms and sidelights.
- **Chimneys:** Often present on residential examples. Typically brick, often with stone coping.

Art Deco



Example of an Art Deco two-part vertical block.

- Building Forms: On residential examples, typically bungalow or ranch form. Commercial or institutional examples may be one-part commercial block, two-part commercial block, temple front, two-part vertical block, three-part vertical block, or gas stations or service stations.
- Exterior Walls: Brick masonry, stone masonry, concrete block, stucco, or ceramic tile. Often feature abstracted or geometric detailing in stone or metal.
- Foundations: Concrete slab.
- Porches: Residential examples often feature cantilevered flat awnings. Patios or balconies with metal railings may be present.
- Roofs: Flat.
- Storefronts: Commercial examples typically feature metal storefronts.
- Canopies: Commercial examples typically feature cantilevered concrete or metal canopies with a flat roof form.
- Windows: Typically metal-sash casement. Glass block sometimes present.
- Doors: Typically wood or metal, often with glazing.
- Chimneys: Seldom present.

Moderne



Example of a Moderne one-part commercial block. Note cantilevered canopy.

- Building Forms: On residential examples, typically bungalow or ranch form. Commercial or institutional examples are typically one-part commercial blocks or gas stations.
- Exterior Walls: Stucco. Corners often rounded.
- Foundations: Concrete slab.
- Porches: Residential examples often feature cantilevered flat awnings. Patios or balconies with metal railings may be present.
- Roofs: Flat.
- Storefronts: Commercial examples typically feature metal storefronts.
- Canopies: Commercial examples typically feature cantilevered concrete or metal canopies with a flat or swept roof form.
- Windows: Typically metal-sash casement or jalousie. Glass block sometimes present.
- Doors: Typically wood or metal, often with glazing.
- Chimneys: If present, stucco.

Ranch



Example of Ranch Style applied to Ranch building form. Note low pitched roof and picture windows.

- Building Forms: Typically applied to ranch house forms. Seldom applied to commercial or institutional buildings.
- Exterior Walls: Often brick or stone masonry, often using Roman brick or flagstone; sometimes wood siding or asbestos shingle siding.
- Foundations: Concrete slab.
- Porches: If present, typically recessed under main roof form and supported by simple wood posts or metal posts, sometimes adorned with decorative wrought iron. Floor typically concrete. Integral stone or brick planters often are evident. Details may exhibit influences of the Colonial Revival or Tudor Revival Styles.
- Roofs: Low-sloped hipped or side-gabled, with deep eaves. Clerestory windows sometimes present at gable ends or below eaves. Details may exhibit influences of the Colonial Revival or Tudor Revival Styles.
- Storefronts: Seldom present on Ranch Style buildings.
- Canopies: Seldom present on Ranch Style buildings.
- Windows: Double-hung, casement, awning or jalousie, with wood or metal sash. Picture windows often present at front façade.
- Doors: Wood, often with small lites in geometric patterns. Metal or wood screen doors.
- Chimneys: If present, broad and simple brick or stone.

Modern



A Modern commercial block building.

- Building Form: Boxy or planar in appearance.
- Exterior Walls: Glass, steel, concrete, aluminum, synthetic materials. No applied ornament. Sometimes curved or sharp angles used to create Modernist details.
- Foundation: Concrete slab.
- Porches: Cantilevered flat awnings, or recessed under flat roof.
- Roofs: Flat, A-frame, angular, vaulted, or irregular.
- Windows: Fixed with metal sash.
- Doors: Typically metal with glazing.
- Chimneys: Not typical.

Contemporary



A Contemporary Style church. Note the cantilevered canopy over the entry and the angled end walls.

- Building Form: Irregular or ranch.
- Exterior Walls: Concrete, stucco, wood, Roman brick, flagstone, glass, or tile. No applied ornament. Often curving or angular.
- Foundation: Concrete slab.
- Porches: Cantilevered flat awnings, or recessed under flat roof.
- Roofs: Flat, A-frame, angular, vaulted, or irregular.
- Windows: Double-hung, casement, or fixed, with metal or wood sash.
- Doors: Typically wood or metal, often with glazing.
- Chimneys: If present, typically brick or stone.

LANDSCAPE AND STREETScape FEATURES



Front Setbacks



Side Setbacks



Streets



Railroad

Front Setbacks

The distance between the street and the front facades of historic buildings lends the streetscape within a historic district a distinctive pattern. Generally, in residential historic districts, buildings are set back from the street with landscaped front yards, while in a commercial historic district, buildings are set forward flush with the property boundary.

Side Setbacks

The space between adjacent buildings also gives character to the streetscapes in historic districts. In residential districts, houses are usually structurally independent, with a space between one another. In commercial districts, the structures of adjacent buildings often share party walls, with the buildings sited immediately adjacent to one another.

Streets

The width, slope, and paving materials of streets are character-defining features within a historic district. As a utilitarian feature, the roadway may have been resurfaced over time and feature layers of different materials. Brick streets are a historically significant feature within portions of the Charlestown Cultural District. Brick streets are an infrastructural improvement dating from the early twentieth century, when the automobile first became popular.

Railroads and Street Cars

Railroads tracks are significant transportation features that played an important role in the development of Lake Charles. The (historic) location of railroad or streetcar tracks is important to the understanding of many of the buildings in the surrounding context, especially rail-oriented buildings such as depots and warehouses.



Curbs



Sidewalks



Walkways



Fences



Perimeter Walls

Curbs

Stone or concrete curbing is part of the roadway infrastructure in a historic district. Because curbing is a utilitarian roadway feature, it may have been resurfaced over time and feature layers of several different materials. In addition, the curbing may have inlaid tiles or painted street signs and other decorative features, such as stamped imprints.

Sidewalks

Concrete or brick sidewalks are an often overlooked feature that contributes to the character of historic districts. Sidewalks run parallel with public streets and are adjacent to curbs in the Charlestown Cultural District. Sidewalk detailing may include inlaid tiles at the entry to buildings. Features such as ramps may have been added to provide accessibility into buildings for handicapped persons.

Walkways

A walkway leads from a sidewalk to the front door of an individual building. Walkways may be paved with concrete, brick, stone, or aggregate, and their path may be straight or winding.

Driveways

A driveway leads from the public street onto an individual property. Often, driveways provide access to an automobile-oriented feature, such as a garage, carport, or *porte cochere*. Driveways may be paved with concrete, brick, stone, or aggregate, and their path may be straight or winding.

Fences

Fences typically are used to delineate the rear and side boundaries of properties in a historic district. In residential districts, though, front yards typically are open and un-fenced. The materials used for fences typically correspond to the date of construction and the materials and style of the associated building, ranging from wood to brick to decorative metal.

Perimeter Walls

Perimeter walls are low, decorative walls often used to demark the edges of a yard or garden in a residential historic district. Perimeter walls also may serve as terraces to negotiate a change in topography. Perimeter walls typically are constructed of brick, stone, or concrete and may include metal, stone, or tile detailing.



Signage



Lamp Posts



Street Markers



Tie Posts



Lakeshore

Signage

Signage includes not only signs attached to individual buildings, but also street signs, traffic signs, and informational signs. Historically, signs may have been painted on masonry walls or on glass storefronts. Signs also were printed on metal plates that are mounted on concrete or metal posts.

Lamp Posts

Lamp posts often were erected in historic districts in the early twentieth century, as electricity became widespread. Lamp posts may have been installed during the earliest development in the district, or they may have been added at a later date. Lamp posts may be constructed of metal, wood, or concrete, with glass globes.

Street Markers

Before the commonplace use of contemporary street signs, concrete obelisks were placed at intersections to denote streets. The street names would have been stamped onto the sides of the markers.

Tie Posts

Tie posts were commonly used in historic residential areas to tether horses before vehicular traffic became widespread.

Lakeshore

The lakeshore is an important landscape feature as it defines the western edge of the Charlestown Cultural District.

CHARLESTOWN CULTURAL DISTRICT DESIGN GUIDELINES

GENERAL

All work requiring design review (Certificate of Appropriateness) within the district will follow the design guidelines set forth below. The design guidelines are based upon the Secretary of Interior's Standards for Preservation, Rehabilitation, Restoration, or New Construction, as appropriate. These Standards can be found in the Appendices to these design guidelines and on the National Park Service website at www.nps.gov.

The following design guidelines clarify the interpretation of the *Secretary of the Interior's Standards* for design review in the Charlestown Cultural District. These standards apply to all resources within the district, both Contributing and Non-contributing.

The treatments outlined in this document apply to different types of buildings. The sections *Rehabilitation of Contributing Buildings* and *Additions to Contributing Buildings* apply to those historic buildings that are historic-age (50 years or older) **and** retain enough integrity to contribute to the ability of the Charlestown Cultural District to convey its historic significance. The section on *Non-contributing Buildings* applies to those buildings that are historic-age but do not retain integrity **or** are not of historic-age (infill). These categorizations apply to all of the resources in the Charlestown Cultural District.

Retention of Historic Style

Retain the character-defining features of each building based on its original building form and architectural style, as described in the *Architectural Character* section of these design guidelines. Avoid alterations to the original fabric of historic buildings.

Reversing non-historic alterations that detract from original historic style may be appropriate.

Avoidance of False Historicism

Do not add stylistic elements that were not originally present, as evidenced by historic documentation. Avoid alterations that have no historic basis and that seek to create the appearance of a different architectural period. For example, do not add Victorian trim to a Craftsman bungalow, or Craftsman details to a 1950s Ranch Style house. Reversing non-historic alterations that detract from original historic style may be appropriate. Alterations and renovations should be sympathetic to a building's historic fabric but need not and should not replicate historic materials.

Sequence of Appropriate Treatment Options

Treatment for historic materials within the District shall follow the sequence of priorities set forth in the Secretary's Standards: preservation first, then rehabilitation, then restoration of missing elements if necessary, and finally, new construction. In order to obtain a Certificate of Appropriateness, the applicant shall objectively demonstrate that the proposed project has selected the least intrusive treatment option that is feasible because of the condition of the existing historic materials.

For additional guidance, the National Park Service publishes *Interpreting the Standards* Bulletins and *Preservation Briefs*, available online at the following sites:

<http://www.nps.gov/tps/standards.htm>

<http://www.nps.gov/tps/how-to-preserve/briefs.htm>

When to Preserve:

Repair rather than replace deteriorated historic features and architectural elements whenever possible. Many times, materials that initially appear beyond repair may be preserved successfully. Guidelines for the conservation of historic materials are set forth in *Appendix J* to these design guidelines and are available in National Park Service Preservation Briefs.

When to Rehabilitate:

If an original architectural feature has deteriorated beyond repair, the replacement shall match the historic feature in size, scale, profile, and finish. The substitution of compatible recycled historic materials is acceptable, provided that the replacement material is compatible with the historic style and character of the resource. Synthetic or composite replacement materials may be appropriate, provided that they do not compromise the preservation of the surrounding historic fabric. In order to be appropriate, synthetic or composite replacement materials shall match the original in size, scale, profile, and finish. Additional recommendations for the rehabilitation of historic materials are provided in *Appendix F* to these design guidelines.

When to Restore:

Missing architectural features may be restored using photographs, historic architectural drawings, or physical evidence as a guide. Physical evidence might include other matching elements that remain extant on the building or a “ghost” showing where the missing element historically was attached. The restored elements shall match the original in size, scale, profile, and finish. Reconstruction of an entire missing building typically is not appropriate.

When to Construct New:

New construction within a historic district is appropriate only if it will not entail demolition or significant alteration of an extant contributing resource. For example, new construction may be appropriate on an empty lot, or to the rear of a contributing resource.

Architectural Barriers and Accessibility

Projects such as the construction of Americans with Disabilities Act (ADA) ramps, lifts, and ADA-accessible entrances have the potential to impact character-defining features of a historic building. Contact the Louisiana Division of Historic Preservation and/or the Louisiana Office of the State Fire Marshall Public Safety Services for inquiries regarding Accessibility Standards.

Energy Efficiency

Construction of any new structures or alterations of existing structures shall be done in such a way as to maximize energy efficiency while maintaining historic character. In no case, however, shall the maximization of energy efficiency be used as a reason to demolish a historic, contributing, or potentially contributing structure, or to change a structure in such a way that its historic features are modified or obliterated.

REHABILITATION OF HISTORIC BUILDINGS

The guidelines set forth on the following pages apply to individual contributing buildings within the Charlestown Cultural District. (For noncontributing buildings within a historic district, refer to the discussion on Non-Contributing Buildings.)

Exterior Walls/Murals



The character of an exterior wall is defined by its texture, color, and pattern. Note use of brick and stone string course.



Note the juxtaposition of materials in this exterior wall.



Use of multiple materials is a character-defining feature of some buildings. Note the glass and ceramic spandrel curtain wall.



Painted finishes are a character-defining feature of many exterior walls but may affect the behavior of the material underneath.

- a. Retain the original façades of the building that are visible from the public right-of-way. Do not change the character, appearance, configuration, or materials of the façade, except to restore buildings to their original appearance.
- b. Do not add architectural features to a building that it never had (e.g., do not add decorative stone detailing where it did not exist).
- c. Repair damaged exterior wall materials to the greatest extent possible. Replace only those sections that are deteriorated beyond repair. All repairs should meet the *Secretary's Standards for Rehabilitation* and follow guidelines set forth in National Park Service *Preservation Briefs*. (Refer to the treatment guidelines in *Appendix F*.)
- d. Replace deteriorated wall materials in-kind to match existing wall materials.
- e. Do not apply aluminum, vinyl, or other synthetic siding as a replacement for a primary building material. Artificial siding materials have been documented to cause serious, costly and often irreparable damage to underlying materials and structural members.
- f. The use of smooth siding, not faux wood grain, is permissible in the Charlestown Cultural District when the profile matches that of the historic siding. The use of smooth HardiPlank is permissible on secondary facades of a building that are not visible from the public right-of-way. HardiPlank may not be applied to a historic building's primary (street-facing_ façade).
- g. If conducting a major rehabilitation, the removal of synthetic siding is recommended unless it has been determined that such removal will increase damage to the original surface or that the removal will not accomplish the desired intent. The removal of existing synthetic siding is not required unless the owner proposes to replace the existing siding.
- h. Do not paint or coat previously unfinished masonry surfaces. Moisture may become trapped between the paint and masonry, causing deterioration of the underlying materials and structural members. Remove non-historic paint from historic masonry using the gentlest means possible. (Refer to the treatment guidelines in *Appendix F*.)
- i. Do not add non-historic murals to masonry surfaces. When restoring historic murals or painted signs, paint should be water-permeable, as discussed in the treatment guidelines in *Appendix F*. Any proposed restoration of a historic mural or painted sign must be authorized by the HPC prior to consideration for placement on a building.

- j. When cleaning masonry walls or preparing wood walls for paint, use the gentlest means possible. (Refer to the treatment guidelines in *Appendix F*.)
- k. Non-historic murals shall not be added to historic buildings. Resources providing ideas for more appropriate public art installations are included in *Appendix H*.

Porches



On this porch, the paired columns, cornice, and pedimented roof form are character-defining features of the Classical Revival Style and should be preserved.



Wraparound porches and side porches that were designed to be open to the air should remain open, without screens or glass enclosures. Note the use of "Lake Charles columns" which are paneled, square, and slightly tapered.



The graduated recessing of the arches and columns form an entry porch at this Romanesque Revival Style church.

- a. Front porches are character-defining features for many building forms and architectural styles; do not remove any element of an original front porch.
- b. Do not enclose a front porch. If a front porch is screened, it shall be performed in such a way that it is reversible and does not damage any historic fabric.
- c. Do not add a new porch or deck to the main façade where one never existed.
- d. Repair damaged porch elements in-kind whenever possible. All repairs should meet the *Secretary's Standards for*

- e. *Rehabilitation* and follow guidelines set forth in National Park Service *Preservation Briefs*. (Refer to the treatment guidelines in *Appendix F*.)
- f. If replacement is necessary, replace only those elements deteriorated beyond repair. The replacement element shall match the original in design, profile, finish, and texture. Do not add porch elements that were not historically present.

Roofs



The bell and clock tower are character-defining features of this building in the Italianate Style.



On this Classical Revival government building, the molded cornice, roof balustrades, and dome are important character-defining features.



The green tile roof, cornice, balustrade, and varied roof dormers are character-defining elements of the Queen Anne Style.



Note pyramidal roof, brackets, and eyebrow dormers at this tower on a home with Queen Anne elements.



The terracotta roof parapet with balustrade and cornice is an important feature of this Italianate commercial building.

- a. Use roofing materials that duplicate the appearance and profile of the original materials whenever possible. If the original roofing material previously has been replaced with composition shingle roofing, the existing roofing may be replaced with roofing materials that historically would have been appropriate for the building form and style. For example, if the roofing historically was wood shingle but has been replaced with composition shingle, it is acceptable to replace the existing composition shingle roof with a new composition shingle roof. Refer to the *Architectural Character* section of these design guidelines.
- b. Maintain the shape and slope of the original roof as seen from the street.
- c. Maintain and repair original decorative roof elements such as parapets or cornices. All repairs should meet the *Secretary's*

Standards for Rehabilitation and follow guidelines set forth in National Park Service *Preservation Briefs*. (Refer to the treatment guidelines in *Appendix F*.)

- d. If replacement of deteriorated or missing elements is necessary, replace only those elements deteriorated beyond repair. The replacement element shall match the original in design, profile, finish, and texture.
- e. Do not add decorative roof elements that were not historically present.
- f. Roof sheathing should be properly ventilated.
- g. Protect a leaking roof with plywood and building paper until it can be properly repaired. Building owners should initiate the design review process as soon as a leak appears, and begin repair immediately upon receiving a Certificate of Appropriateness.

Storefronts



Note the proportion of glass to metal in this storefront's doors and windows, as well as the terrazzo flooring at the entry.



The storefront in this three-part vertical block is emphasized by larger windows, a recessed entry, different wall materials, and ornamentation.



The display windows in this storefront project beyond the door, designed to call attention to the display within.

- a. Retain and restore original windows, window surrounds, and screens unless deteriorated beyond repair. Refer to treatment recommendations for windows included in *Appendix F* to these design guidelines
- b. If original storefronts are deteriorated beyond repair, the replacement storefronts shall maintain the same size, profile, configuration, finish and details as the original storefronts.
- c. If the original storefront is no longer extant, the replacement storefront shall restore the size, profile, configuration, and finish of the original to the greatest extent possible. If historic architectural drawings or photographs illustrate the original storefront, or if remnants of the original storefront remain, these shall be used to fabricate the new storefront. If no documentation regarding the appearance of the original storefront exists, then the new storefront shall be appropriate for the building's form and architectural style. Refer to the *Architectural Character* section of these design guidelines.
- d. Tinted or reflective glass is not appropriate for storefronts on historic buildings. Colored or textured glass is only appropriate if historic documentation confirms that it was used in the building during the historic period.
- e. Although some substitute materials, such as extruded aluminum, may be used for replacement storefronts, the appearance of the storefront from the public right-of-way shall closely resemble the original in size, configuration, profile, and finish. Vinyl is not an appropriate substitute material.

Canopies and Awnings



The paint color and curved edges of this cantilevered canopy are character-defining features of the building's Art Deco Style.



The metal canopies of these adjacent buildings are consistent in design and form and feature metal support rods. Note the canopies' subtle downward slope.



A canopy that runs horizontally between the transom above and the storefront below (left) is appropriate. Canopies and awnings should avoid covering windows or transoms.



This concrete cantilevered canopy is consistent with the use of materials in this building.

- a. Do not remove any element of an original front canopy or awning.
- b. Repair damaged canopy elements in-kind whenever possible. All repairs should meet the *Secretary's Standards for Rehabilitation* and follow guidelines set forth in *National Park Service Preservation Briefs*. (Refer to the treatment guidelines in *Appendix F*.)
- c. If replacement is necessary, replace only those elements deteriorated beyond repair. The replacement element shall match the original in design, profile, finish, and texture. Do not add elements that were not historically present.
- d. If the original canopy or awning is no longer extant, the replacement canopy shall restore the size, profile,

- configuration, and finish of the original to the greatest extent possible. If historic architectural drawings or photographs illustrate the original canopy or awning, or if remnants of the original canopy or awning remain, these shall be used to fabricate the new canopy. If no documentation regarding the appearance of the original canopy or awning exists, then the replacement shall be appropriate for the building's form and architectural style. Refer to the *Architectural Character* section of these design guidelines.
- e. Do not add a new canopy, awning, porch, balcony, or deck to the main façade where one never existed.

Windows, Screens, and Shutters



Note simple molding and divided lites at this Gothic arch window.



Stained glass windows are characteristic of Queen Anne Style houses.



The geometric grid of muntins and number of lites in this building's double-hung windows are character-defining features.



The casement windows at the storefront and ribbon windows in the transom complement the façade of this enframed wall Modern building.

- a. Do not enlarge, move, or enclose original window openings on façades visible from the public right-of-way. Do not add new window openings on façades visible from the public right-of-way. It may be appropriate to restore original window openings that have been enclosed.
- b. Retain and restore original windows, window surrounds, and screens unless deteriorated beyond repair. Refer to treatment recommendations for windows included in *Appendix F* to these design guidelines.
- c. Storm windows may provide increased energy efficiency without damaging historic windows. Interior storm windows may be used to maintain the historic exterior appearance of the window and are preferred over exterior storm windows. Storm windows shall be installed in such a way that they do not damage historic fabric.
- d. If original windows or screens are deteriorated beyond repair, replacement windows or screens shall maintain the same size, profile, configuration, finish and details as the original windows or screens. See the following page for illustrations of window elements.
- e. If the original windows or screens are no longer extant, replacement windows or screens shall reflect the size, profile, configuration, and finish that are appropriate for the building's form and architectural style. Refer to the *Architectural Character* section of these design guidelines. Examples of windows configurations for architectural styles in the Charlestown Cultural District and examples comparing inappropriate and appropriate repair and rehabilitation of windows are illustrated on the following pages.
- f. False muntins inserted inside the glass are not permitted. Matching the profile of the original window requires the use of either:
 - i. True divided lites; or
 - ii. Dimensional muntins placed on the outside of the glass, along with spacers on the inside of the glass that are an appropriate color, material, and thickness, so that the window appears to have true divided lites even when viewed from an oblique angle.
- g. Tinted or reflective glass is not appropriate for historic buildings. Colored or textured glass is only appropriate if historic documentation confirms that it was used in the building during the historic period.
- h. Although some substitute materials, such as extruded aluminum, may be used for replacement windows, the

appearance of the window from the public right-of-way shall closely resemble the original in size, configuration, profile, and finish. Appropriate materials to use are wood, metal clad wood, and wood clad composite. Metal may be appropriate for more modern buildings like Ranch Style homes. **Vinyl is not an appropriate substitute material.** Acceptable replacement windows and materials will be examined on a case-by-case basis.

- i. Exterior shutters were historically used as devices to provide privacy and protection from the elements and are important window features of some residences in the Charlestown Cultural District. They were not used on all buildings and are often dependant on a building's style. The historic existence of shutters can be determined by examining a building for previously existing hardware (i.e. hinges or tiebacks) and attachments (i.e. screw holes in the window casing).
- i. Attention should be paid to a building's style—not all shutter types are appropriate for all buildings.
- ii. Shutters should be operable—they should be able to open and close and fill the entire window opening when closed—if they were originally.
- iii. Historic wood shutters should be retained and maintained when possible.
- iv. Historic shutter hardware should be retained and maintained when possible.
- v. Do not use shutters that do replicate the dimension and proportions of historic wood shutters.
- vi. Do not install shutters in locations where they would not have existed historically.
- j. Emphasis should be placed on the overall final appearance of the window, window configuration, and arrangement of windows, not necessarily on the details of materials.

Components of Wood and Steel Windows.

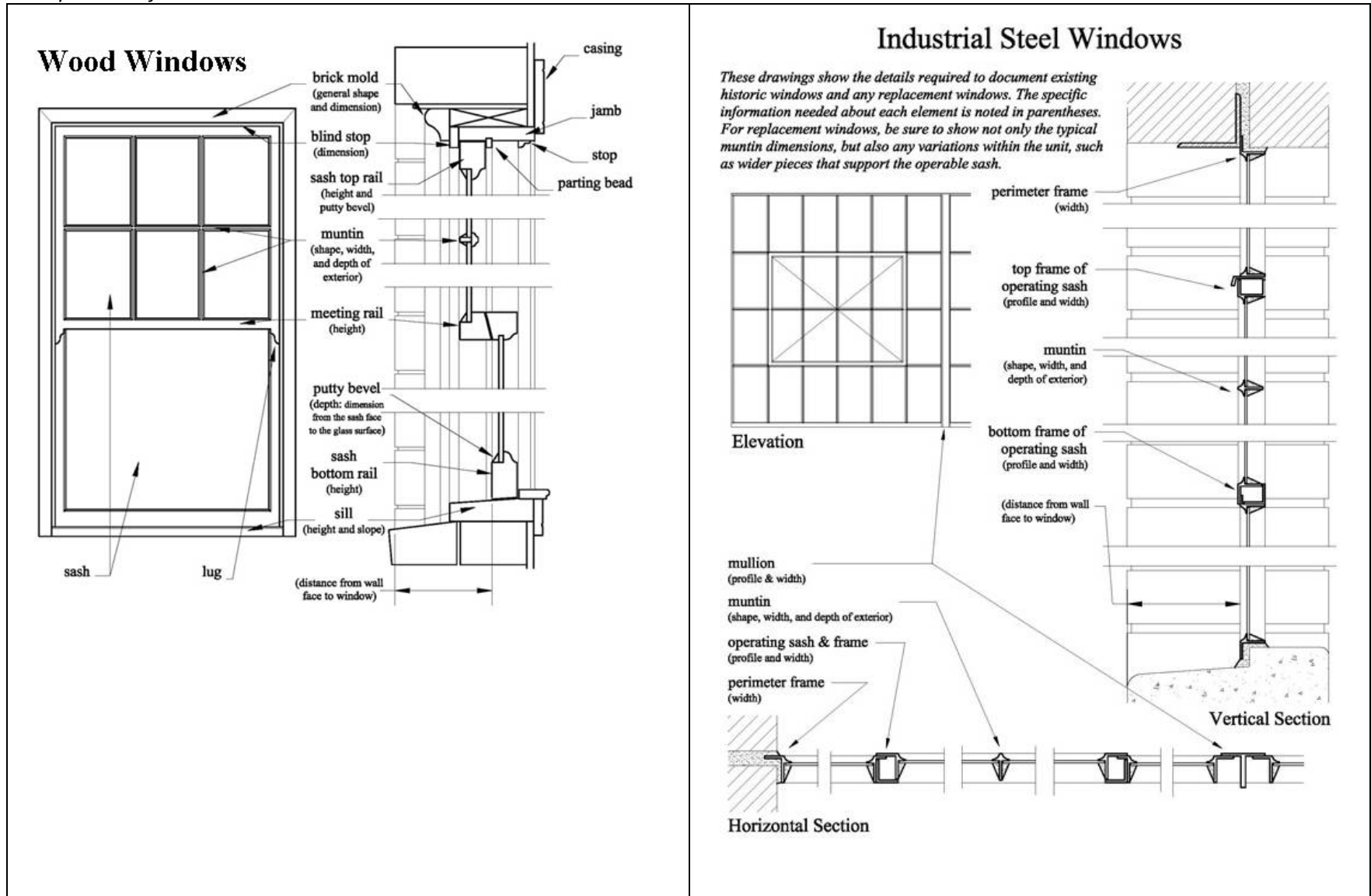
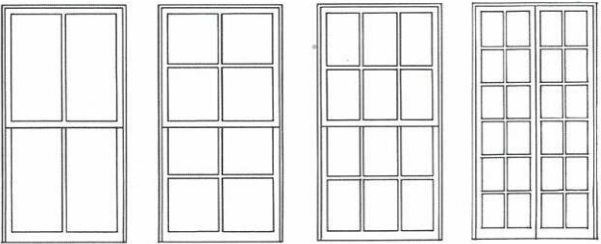

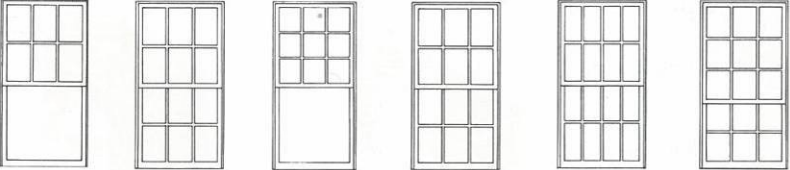
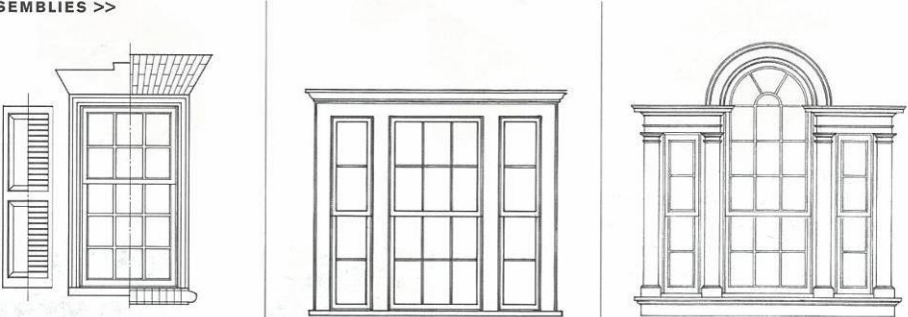

Illustration of historic wood window. (Source: National Park Service.)

Illustration of historic steel window. (Source: National Park Service.)

Common Windows in the Charlestown Cultural District by Architectural Style

National Folk/Colonial Revival Styles	Classical Revival/Neoclassical Style
<p>STANDARD WINDOWS >></p>  <p>WINDOW ASSEMBLIES >></p>  <p>Dormer Windows</p> <p>Floor-to-Ceiling Window</p>	<p>STANDARD WINDOWS >></p>  <p>WINDOW ASSEMBLIES >></p>  <p>Simple Window</p> <p>Common Triple Window</p> <p>Ornate Palladian Window</p>

(Source: Louisiana Speaks Pattern Book.)

Gothic Revival Style

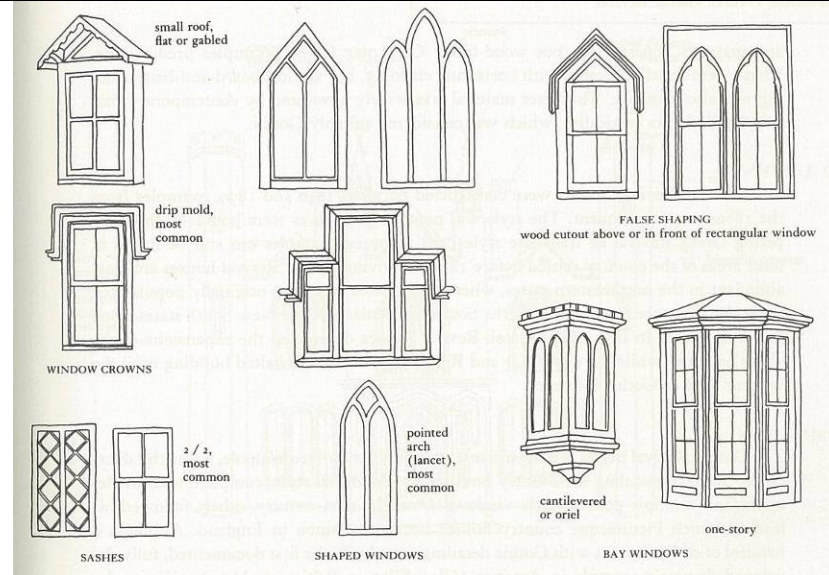

Renaissance Revival Style

Typical arched openings with Classical Revival/Neoclassical frames:

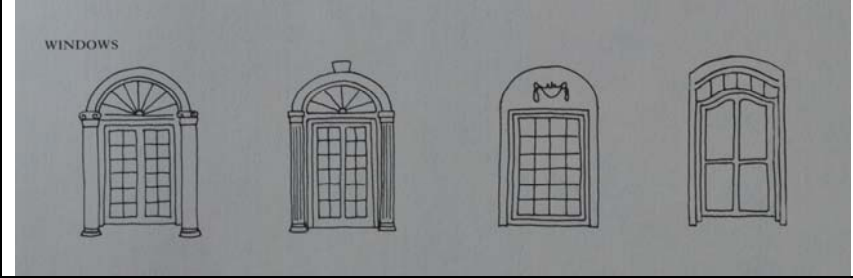

Romanesque Revival Style

Common Elaborations:

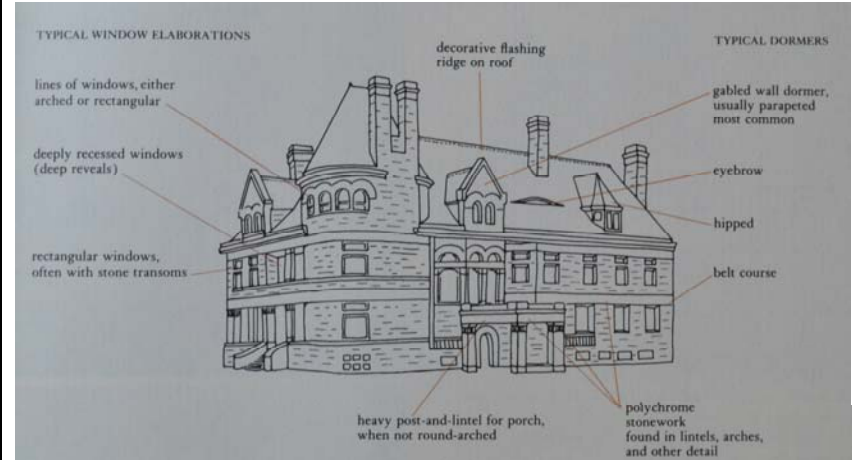

(Source: A Field Guide to American Houses.)

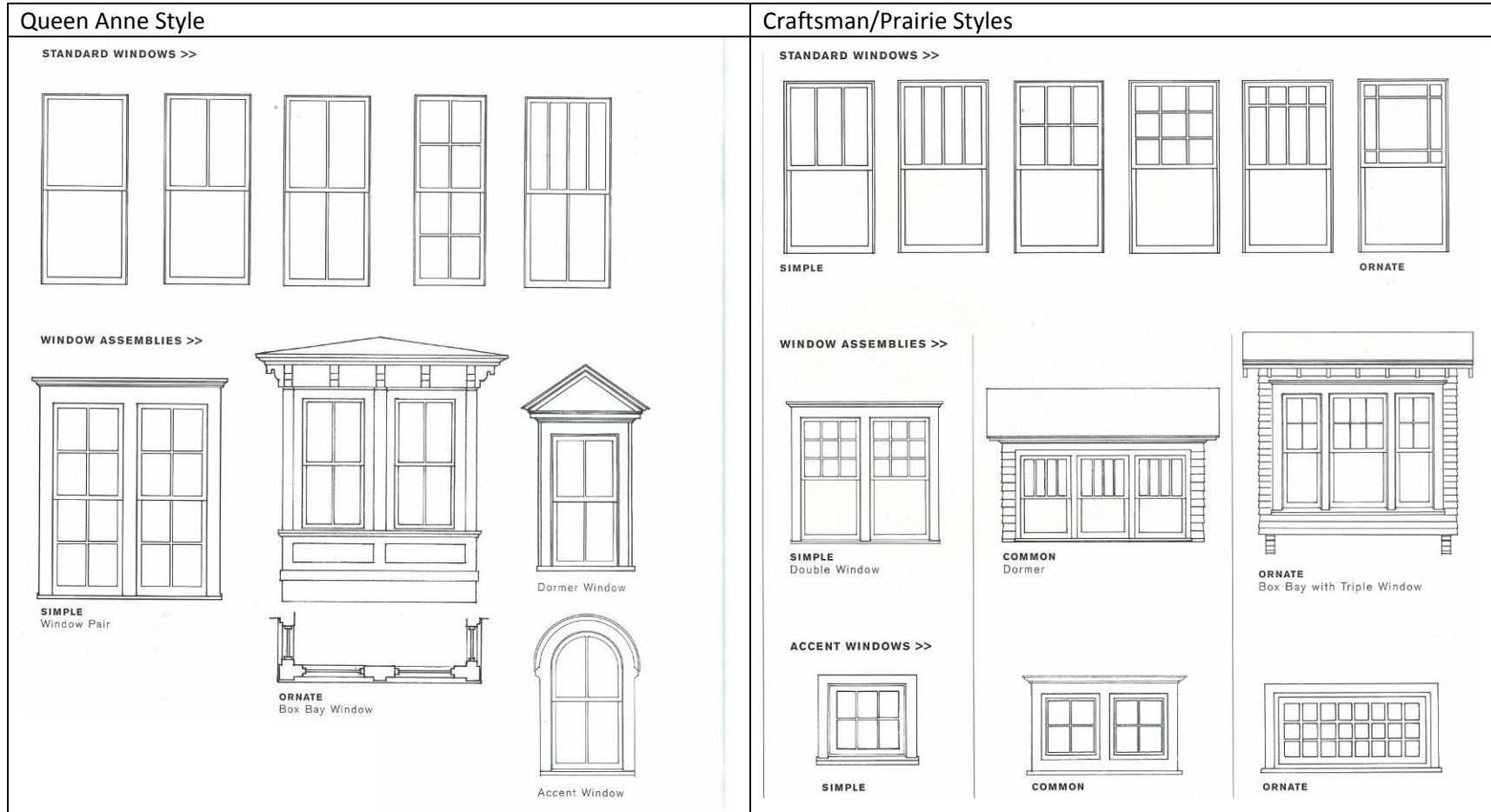



(Source: Louisiana Speaks Pattern Book.)

Ranch, Modern, and Contemporary Styles – These styles were built in the recent past, so the need for window replacement of these historic buildings is less likely. Ranch Style residences

typically feature fixed picture windows, single-hung windows, and/or ribbons of fixed or casement windows.

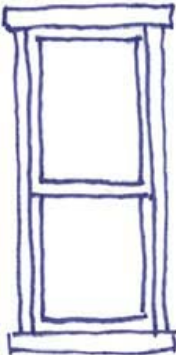
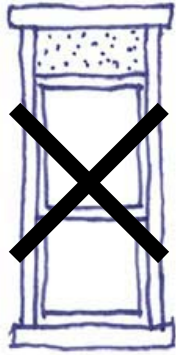
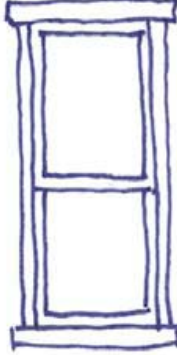
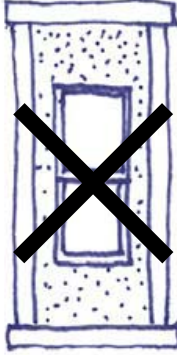
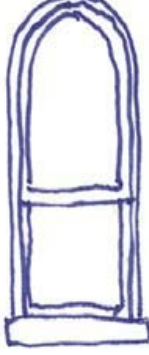
Inappropriate Replacement Windows

Historic	Replacement	Historic	Replacement	Historic	Replacement
					
<i>Infill panels should not be installed. These replacement windows are not sized to fit the original window openings</i>					

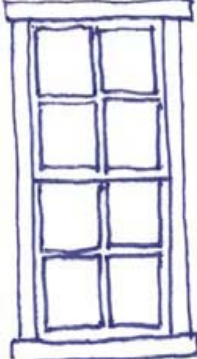
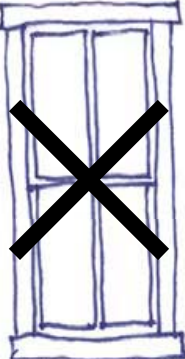
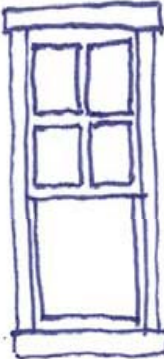
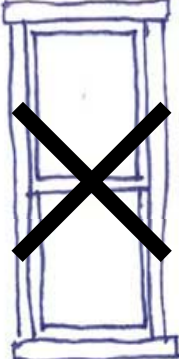
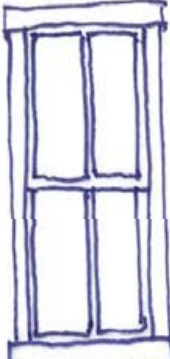
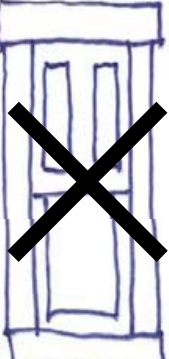
Historic	Replacement	Historic	Replacement	Historic	Replacement
					
<i>The light configuration of the replacement window should match the four-over-four light configuration of the historic window.</i>		<i>The light configuration of the replacement window should match the four-over-one light configuration of the historic window.</i>		<i>The window proportions of the replacement window should match the proportions of the historic window, including the size of the frame and the muntins.</i>	

(Source: City of New Orleans Historic District Landmarks Commission Guidelines for Windows and Doors.)

Inappropriate Replacement Windows

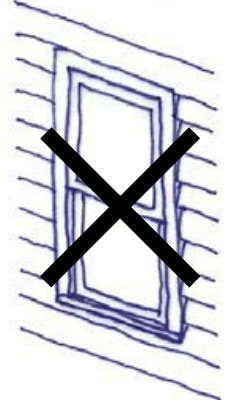
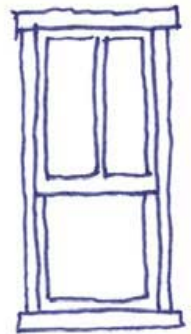
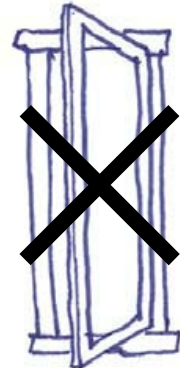
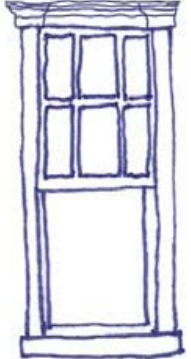
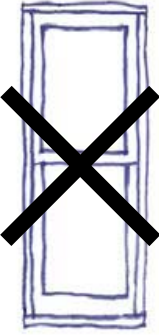

Historic	Replacement	Historic	Replacement	Historic	Replacement
					
<p><i>A replacement window should be setback into the wall the same depth as the historic window.</i></p>		<p><i>The replacement window should be of the same type as a historic window.</i></p>		<p><i>Decorative trim should be retained or replaced when the window is replaced.</i></p>	

(Source: City of New Orleans Historic District Landmarks Commission Guidelines for Windows and Doors.)

Types of Replacement Windows Appropriate for Charlestown Cultural District

 <p><i>(Source: renovation-headquarters.com)</i></p>	 <p><i>(Source: renovation-headquarters.com)</i></p>	 <p><i>(Source: renovation-headquarters.com)</i></p>
<p>Wood</p> <ul style="list-style-type: none"> • preserve the look of historic homes • add most to resale value and appeal aesthetically to buyers • good insulation against heat and cold • can be stained or painted • requires ongoing maintenance • most costly 	<p>Aluminum</p> <ul style="list-style-type: none"> • durable material • ability to disassemble makes replacement of panes easy • frames can be painted • less prone to bending or warping than some other materials • choose thermally improved frame to counter transfer of heat and cold 	<p>Metal Clad Wood</p> <ul style="list-style-type: none"> • cladding protects wood and increases durability • inside of frame can be stained or painted • aluminum frame can be painted • usually the most expensive replacement window

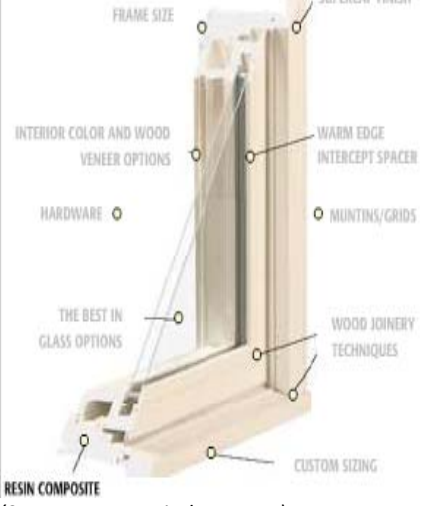
Types of Replacement Windows for Charlestown Cultural District

 <p>(Source: amscowindows.com)</p>	 <p>(Source: renovation-headquarters.com)</p>
<p>Wood Clad Composite</p> <ul style="list-style-type: none"> • core can be made of various materials <ul style="list-style-type: none"> ○ resin (shown in above example) ○ fiberglass ○ combination of sawdust, wood chips, pulverized vinyl • look of wood without the expense • frames can be stained or painted • good insulation and durability; moisture resistant • little maintenance required 	<p>Steel</p> <ul style="list-style-type: none"> • strong frames can hold larger panes of glass • durable and weather-resistant • can be painted • can be manufactured to match windows in older homes

Fiberglass replacement windows are new to the market and, therefore, not common.

Major Manufacturers of Replacement Windows

AMSCO Windows
 Andersen Windows
 Gerkin Windows

JELD-WEN Windows
 Loewen Windows
 Marvin Windows

Milgard Windows
 Pella Windows
 Silver Line Windows

Simton Windows
 Thermal Industries Windows

Shutter Types

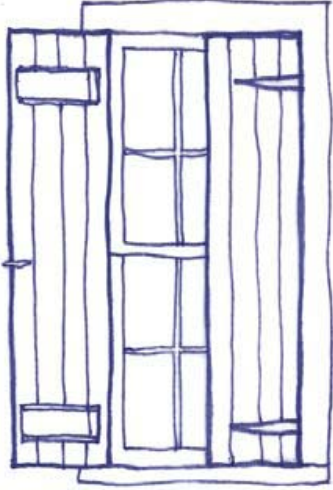
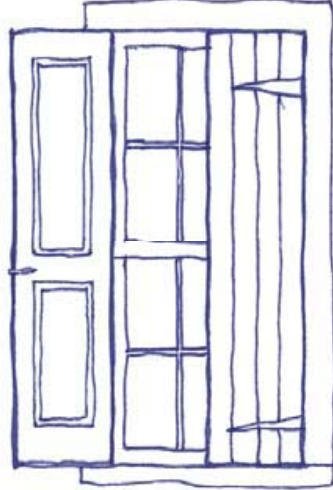
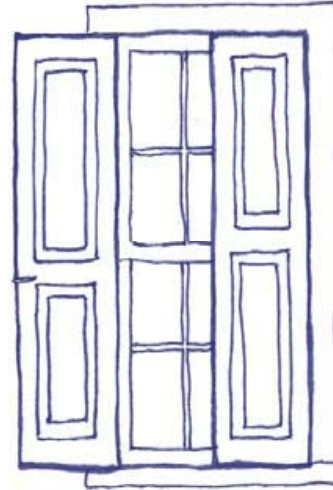
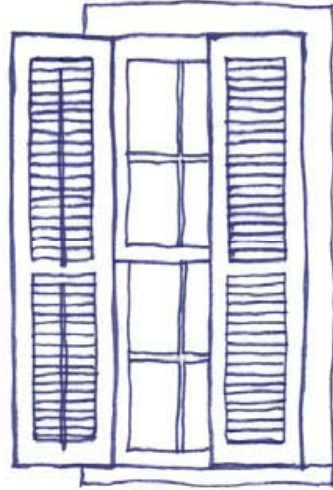
			
<p><i>Batten Shutter – vertical boards connected with horizontal boards on inside face. Hung on wrought-iron strap hinges.</i></p> <p>Appropriate Applications:</p> <ul style="list-style-type: none"> • Colonial Revival Style homes in the Louisiana vernacular tradition. 	<p><i>Vertical Board/Rail and Stile Shutter – outside face same as batten shutters. Inside face in paneled with stiles and rails and has molded trim detailing. Hung on wrought-iron strap hinges.</i></p> <p>Appropriate Applications:</p> <ul style="list-style-type: none"> • Colonial Revival Style homes in the Louisiana vernacular tradition 	<p><i>Paneled Shutter – panels of wood held in place by moldings supported by frames of rails and stiles. Hung on a variety of hinges depending on date of construction.</i></p> <p>Appropriate Applications:</p> <ul style="list-style-type: none"> • Residences in late 19th century through mid-20th century styles. 	<p><i>Louvered Shutter – Fixed or operable wood slats supported by frames of rails and stiles.</i></p> <p>Appropriate Applications:</p> <ul style="list-style-type: none"> • Residences in mid- to late 19th century styles.

(Source: City of New Orleans Historic District Landmarks Commission Guidelines for Windows and Doors.)

Shutters and Architectural Styles

Colonial Revival

- batten shutters
- louvered shutters; may be fixed on upper stories

Gothic Revival

- Paneled shutters, custom to fit pointed arch openings
- Louvered shutters, operable or fixed

Classical Revival/Neoclassical

- Typically without shutters
- May have shutters (operable or fixed) on side facades

Craftsman

- Typically lack have shutters or only shutters on side facades
- Operable louvered or paneled with cutouts in Craftsman Style motifs

*Shutters are generally not found on Tudor Revival, Spanish Eclectic, and Ranch Style buildings. Minimal Traditional Style residences may have paneled or louvered shutters depending on the style on which the home is loosely based. Shutters may be inoperable.

Inappropriate Shutter Applications

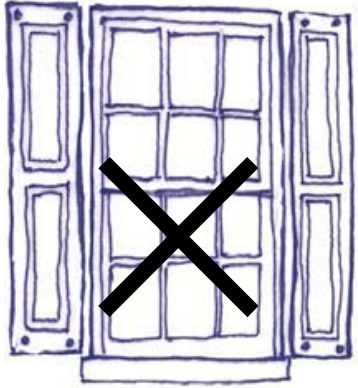
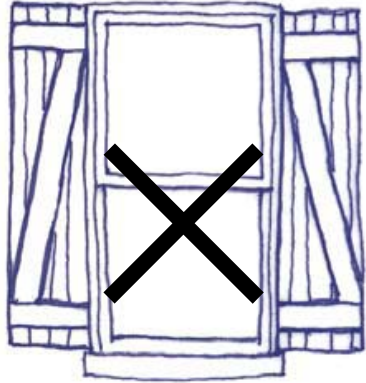
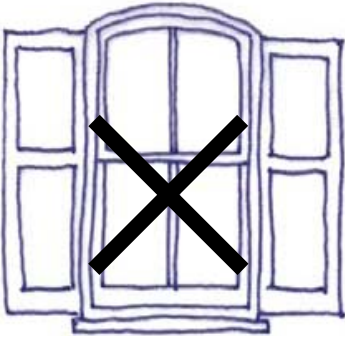
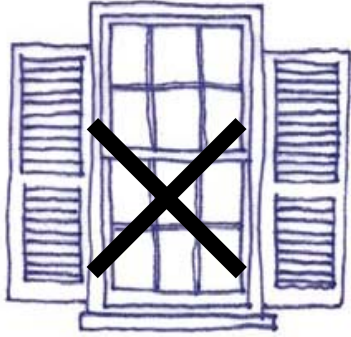
			
<p><i>Shutters at these six-over-six double-hung windows are screwed in and, therefore, inoperable.</i></p>	<p><i>Z-shutters are not appropriate at this double-hung window.</i></p>	<p><i>Paneled shutters do not fit the opening of this arched window.</i></p>	<p><i>Louvered shutters are not the correct size for this six-over-six, double-hung window.</i></p>

(Source: City of New Orleans Historic District Landmarks Commission Guidelines for Windows and Doors.)

*Paired windows generally do not have shutters.

Doors



The rusticated door surround with column supports and paneled wood doors are character-defining features of this Romanesque Revival building.



Note the proportions of the doorway and of the glazing to the wood.



The overhead doors are character-defining features of this service-bay business.



Note the segmental arched surround framing the door with sidelights and fanlight.

- a. Do not enlarge, move, or enclose original door openings. It may be appropriate to restore original door openings that have been enclosed.
- b. Retain original doors, door surrounds, sidelights, and transoms, unless deteriorated beyond repair. Refer to treatment recommendations for historic materials included in *Appendix F* to these design guidelines.
- c. If a door, door surround, sidelight, or transom is deteriorated beyond repair and a replacement is necessary, the style, materials, and finish of the replacement shall reflect the style and period of the building. Refer to the *Architectural Character* section of these design guidelines. Solid steel or hollow-wood doors are not appropriate for main entries for resources in Charlestown Cultural District designated to date. Steel doors may be appropriate for industrial or modern resources designated in the district in the future.

Common Doors in the Charlestown Cultural District by Architectural Style

National Folk/Colonial Revival Styles

DOOR TYPES

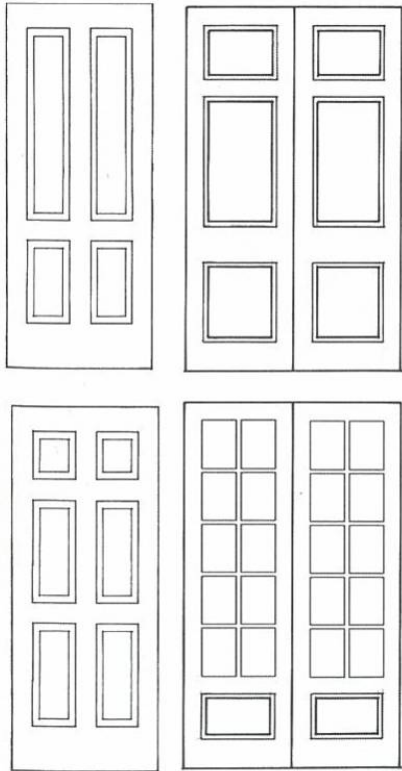

DOOR ASSEMBLIES >>

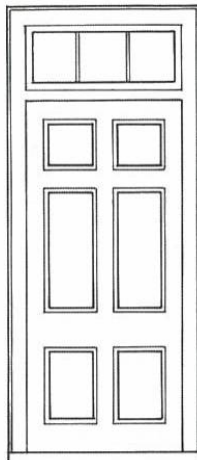

COMMON
Single Door with Transom

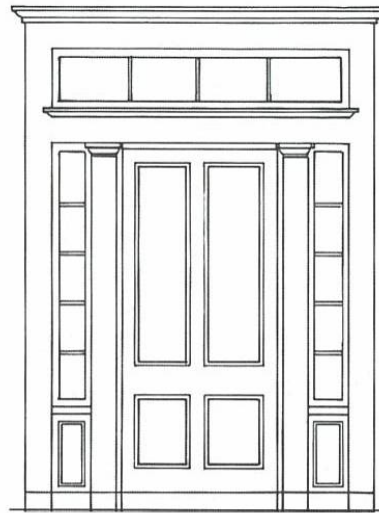

ORNATE
Single Door with Transom and Side Lights

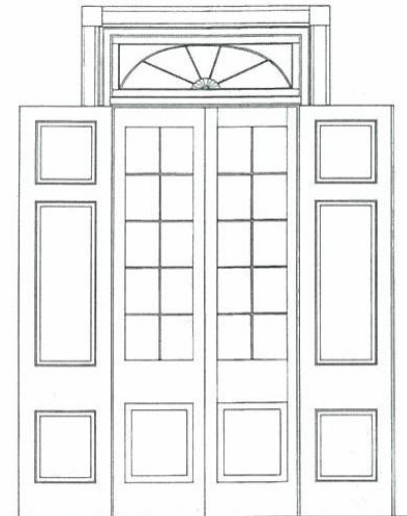

ORNATE
Double Door with Transom and Shutters

(Source: Louisiana Speaks Pattern Book.)

Classical Revival/Neoclassical Style

DOOR TYPES

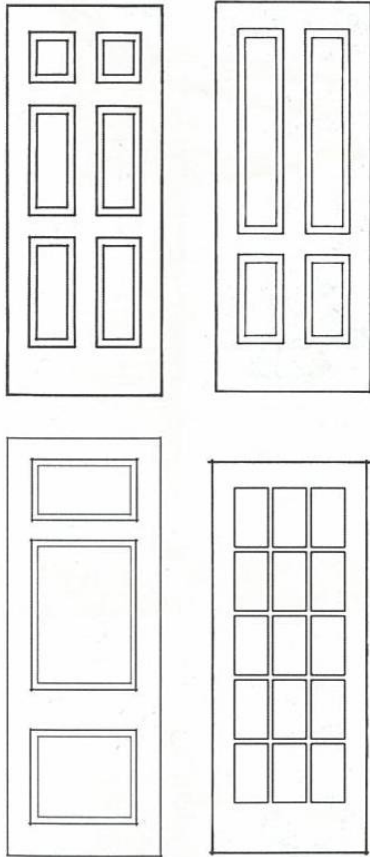

DOOR ASSEMBLIES >>

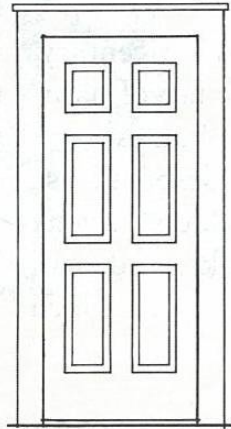

SIMPLE
Door

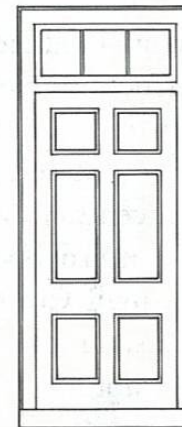
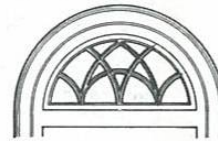

COMMON
Door with Transom



ORNATE
Door with Transom
and Sidelights

(Source: Louisiana Speaks Pattern Book.)

Gothic Revival Style

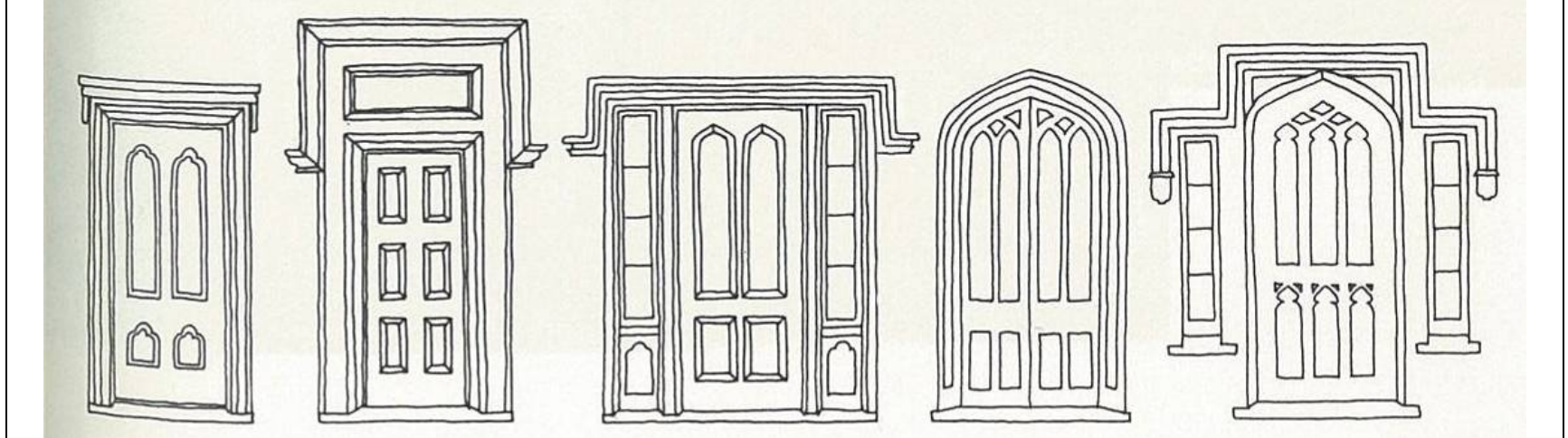

(Source: A Field Guide to American Houses.)

Renaissance Revival Style

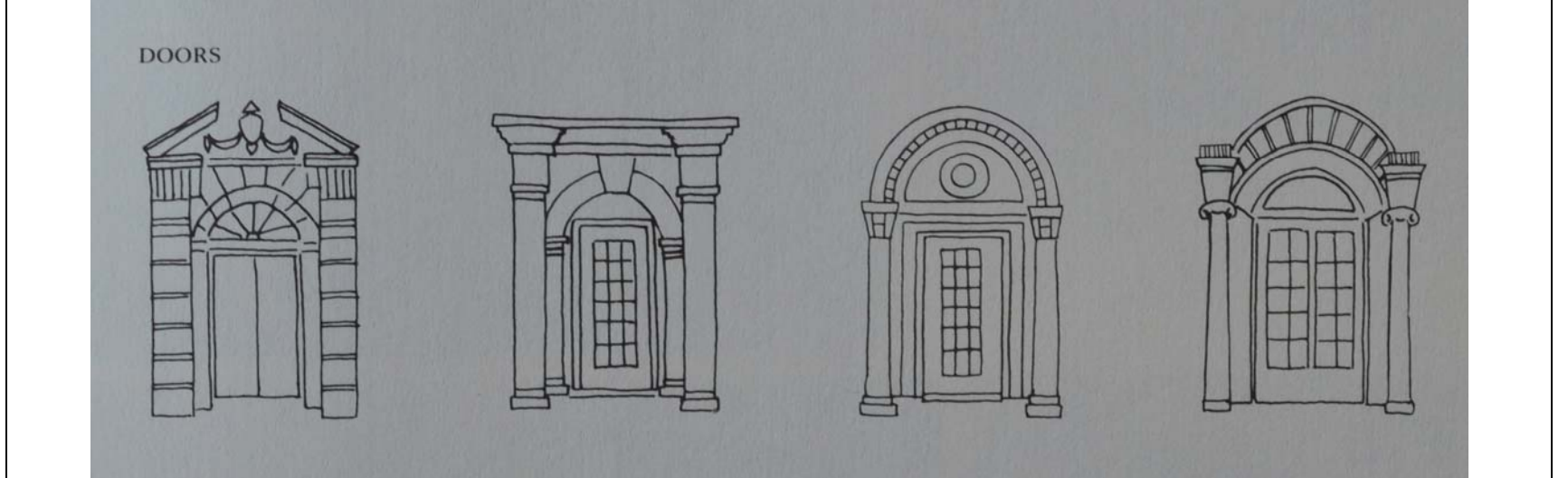

(Source: A Field Guide to American Houses.)

Queen Anne Style

DOOR TYPES

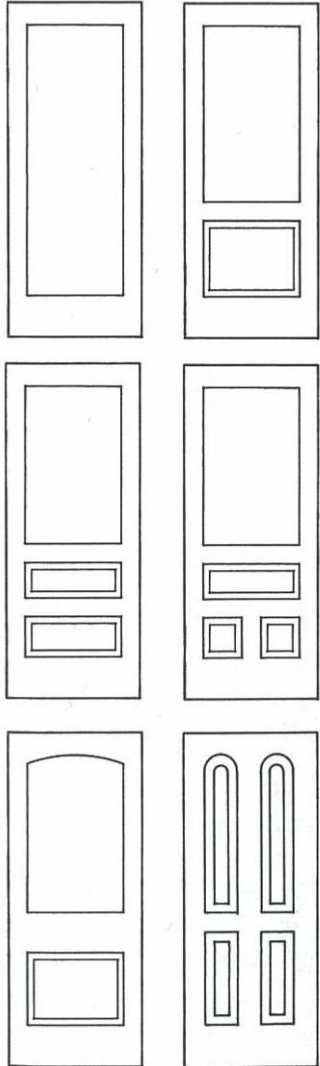

DOOR ASSEMBLIES >>

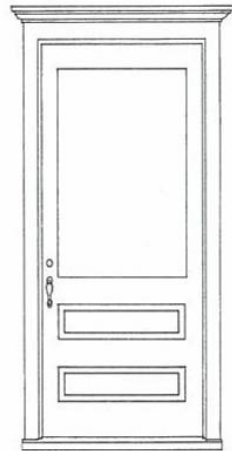

COMMON

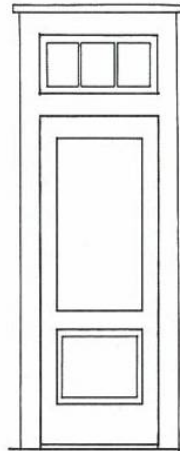

COMMON

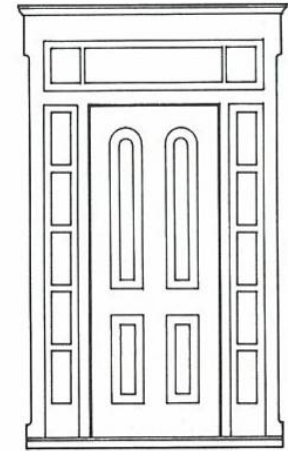

ORNATE

(Source: Louisiana Speaks Pattern Book.)

Craftsman/Prairie Styles

DOOR TYPES

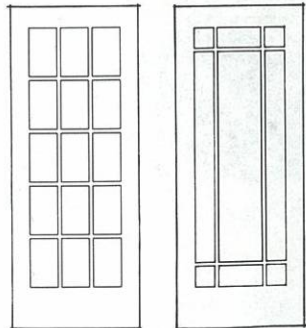
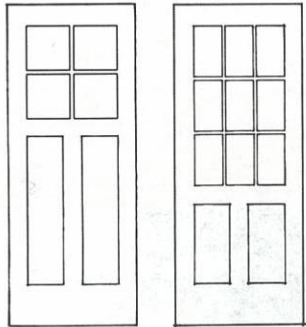
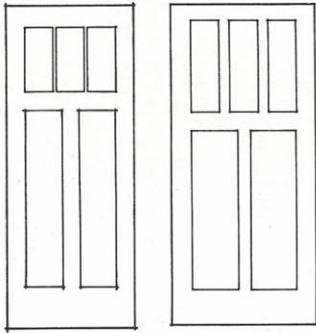

ORNATE

DOOR ASSEMBLIES >>

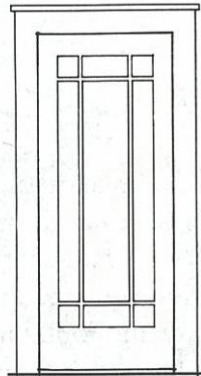

SIMPLE
Single Door

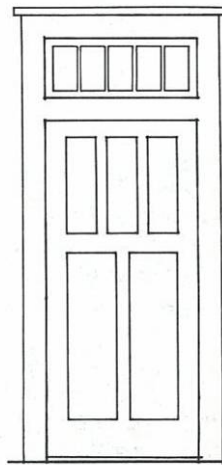

COMMON
Single Door with
Transom

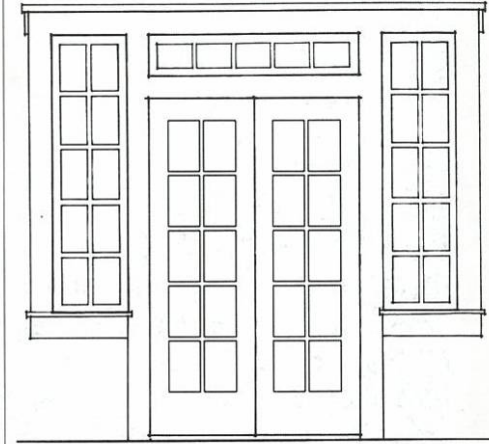

ORNATE
Double Door with
Transom and
Sidelights

(Source: Louisiana Speaks Pattern Book.)

Chimneys



Note the tapered form of the chimney on this Craftsman Style house.



Note the height of the chimney.



The corbelling and metal flue are character-defining features of this chimney.



Note the relationship between the width of the chimney and the width of the front façade.

a. Maintain and repair original chimneys. Refer to treatment recommendations and repair methods for historic materials included in *Appendix F* to these design guidelines.

b. If new chimneys are added, they shall not be visible on the front of the building as seen from the street.

Mechanical Equipment



Here, mechanical features are mounted on a side façade.



This building's mechanical equipment is inconspicuously mounted on the roof to minimize visibility from the street.

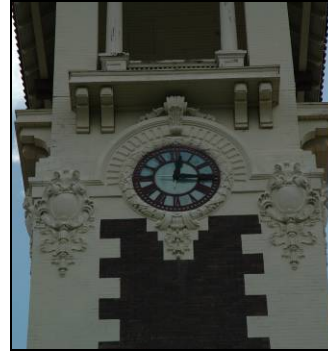

As an important mechanical feature, this historic clock on this building has been maintained.



Original windows are maintained despite the installation of new HVAC units.

- a. Locate all new mechanical equipment out of view from the public right-of-way, to the rear or side of the building.
- b. When mechanical equipment must be attached to the exterior wall of the building, do not damage the original exterior wall material. For masonry walls, all attachments shall anchor into the mortar rather than the masonry unit.
- c. Whenever possible, locate heating, ventilating, and air conditioning (HVAC) units, solar panels, satellite dishes, communication towers, antenna, and wind-powered energy systems so that they are not visible from the street. Appropriate locations may include the back of the roof, the ground, or the roof of an outbuilding.

Signage



When signage is integral to the original design and materials of a building, it should be maintained regardless of changes in tenancy or use.



Note the location of signage identifying the original building in the terrazzo tile floor at the entry.

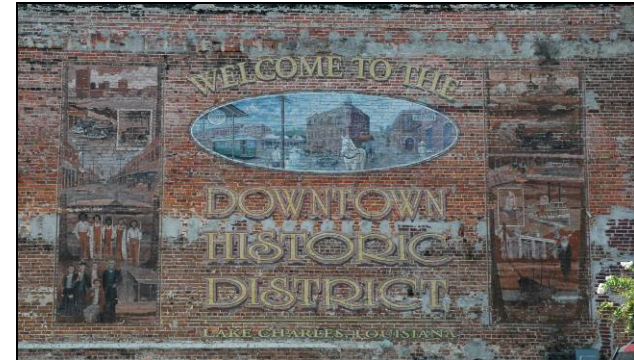

Although this painted sign is not original to the building, it has gained historic significance of its own and merits preservation. Preservation or restoration of the paint should not trap moisture in the brick underneath.

- a. Do not remove any element of an original sign.
- b. Repair or conserve original signs whenever possible. If replacement is necessary, replace only those elements deteriorated beyond repair. All repairs should meet the *Secretary's Standards for Rehabilitation* and follow guidelines set forth in *National Park Service Preservation Briefs*. (Refer to the treatment guidelines in *Appendix F*.)
- c. If an original sign is missing, then it may be accurately restored using historic photographs, historic architectural drawings, or physical evidence. If no documentation exists, refrain from speculatively reconstructing historic signs.
- d. Design new signs so that they reflect the materials and architectural character of the associated landmark or historic district.
- e. Attach new signs in a manner that does not damage the original exterior wall material. For masonry walls, all attachments shall anchor into the mortar rather than the masonry unit.
- f. New signs shall be confined to building façades that front a street, side alley or rear alley or provide a principal entrance. There shall be only one sign on each façade, unless multiple signs were present historically.
- g. For guidelines regarding painted signs and murals, refer to the section on *Exterior Walls/Murals*.

Landscape and Streetscape Features



Infrastructural elements, such as culverts, are character-defining features of the streetscape of historic districts.

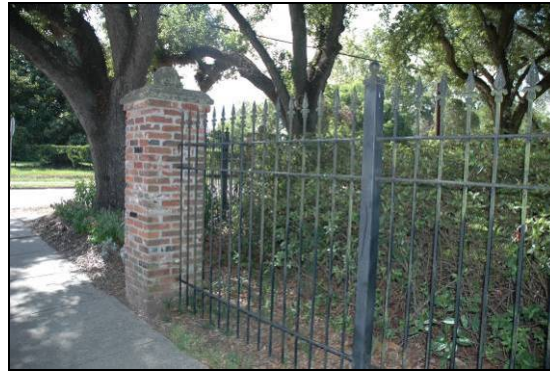

Note the spatial relationship between the street, street trees, sidewalk, and fence.



The architectural style and materials for landscape features often reflect the style and material(s) of the main building(s) on the property.

- a. Vegetation is not regulated by these design guidelines unless the historic district nomination report specifically calls out historic plantings as character-defining features.
- b. Landscape features that are not visible from the public right-of-way are not regulated by these design guidelines.
- c. Do not remove or destroy any built historic landscape or streetscape feature that is visible from the public right-of-way unless deteriorated beyond repair.
- d. Maintain and/or repair damaged landscape and streetscape elements in-kind whenever possible. If replacement is necessary, replace only those elements deteriorated beyond repair. The replacement element shall match the original in design, profile, finish, and texture. Do not add elements that were not historically present.
- e. If original landscape or streetscape features that are visible from the public right-of-way are missing, then they may be accurately restored using historic photographs, historic architectural drawings, or physical evidence. If no documentation exists, refrain from speculatively reconstructing landscape or streetscape elements. For instance, do not add reproduction “historic” street lamps if there is no documentation supporting their historic presence.
- f. Design new landscape or streetscape features so that they reflect the materials and architectural character of the associated historic resource or historic district. For example, if front yards historically were open, then they should not be enclosed with new fences. Similarly, if chain link fences were not historically present in a historic district, then new fences should not be chain link.
- g. Fences are not appropriate in front lawns in the Charlestown Cultural District.
 - i. Fences may be placed at the rear of properties and at the sides of properties if not visible from the public right of way.
- h. Types of fencing appropriate for rear and side yards are: pointed wood picket, Gothic wood picket, capped vertical wood board, horizontal wood board, and metal picket. Masonry walls are not permitted.

- i. The visual impact of parking should be reduced in the Charleston Cultural District, particularly in the Downtown Development District area.
 - i. Surface parking lots shall not be constructed between the front façade of a historic building and the public right-of-way unless present historically.
 - ii. Surface parking lots may be appropriate at the side or rear of a historic building, provided that they do not damage or destroy any character-defining landscape features that are visible from the public right-of-way. If a surface parking lot is constructed at the rear or side of a historic building, consider vegetative screening to shield the view of the parking lot from the public right-of-way.
- j. A balance should be maintained between parking needs and the integrity of the historic district.
 - i. Parking can be shared between commercial uses to fit the context of the historic district.
 - ii. The City should consider variances for shared/on-street parking.
 - iii. Consider whether the parking allotted in the district per City code is actually necessary.

Parking Issues in the Charlestown Cultural District

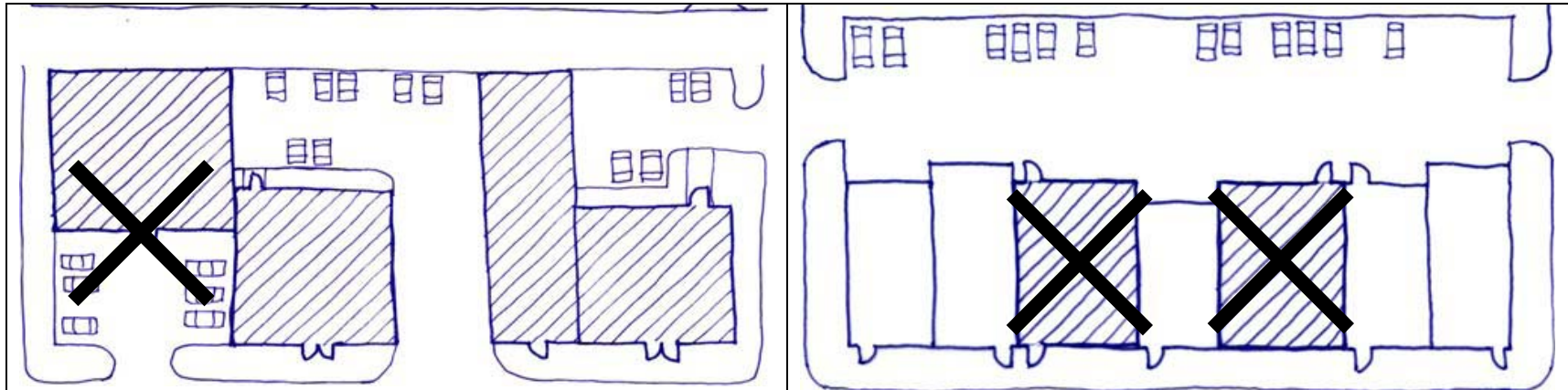

It is not appropriate to place off-street parking lots in front of a historic building as it suggests a different relationship between the building and the streetscape and other commercial buildings.

Where rear parking lots are present, the primary, street-facing entries of a commercial building should be maintained. If appropriate, secondary, rear entries can be added.

ADDITIONS TO CONTRIBUTING BUILDINGS

Preservation of the Original Building

- a. All character-defining features on exterior façades that are visible from the public right-of-way shall remain intact.
- b. Retain as much of the historic building fabric as possible in the construction of the addition.
- c. Do not partially demolish exterior walls that are visible from the public right-of-way to accommodate an addition.
- d. New additions should respect the appearance of the historic portion of the building but need not, and should not replicate the historic material.

Location and Height

Locate additions as inconspicuously as possible. Consider the effect that the addition will have on the existing and neighboring buildings. Large additions may be constructed as separate buildings and connected to the existing building with a linking element such as a breezeway.

- a. Locate all additions toward the rear of the building.
 - i. Never locate an addition flush with the original front façade or projecting beyond the original front façade.
 - ii. Whenever possible, additions shall be located behind the original rear façade of the historic building.
 - iii. The minimum setback between the original façade and the addition shall be complimentary to the proportion and scale of the original building.
- b. Minimize the height of the addition.
 - i. Design one-story additions to one-story buildings whenever possible.
 - ii. Roof heights of new additions shall respect adjacent properties and conform to all City of Lake Charles Zoning and Building codes.

- iii. Within a historic district, the roof height of the addition shall not be taller than the tallest contributing building on a similarly sized lot within the district.

Whenever possible, the roof form of the new addition shall not be visible above the ridgeline of the original roof when the front of the historic building is viewed from the street. Refer to the illustration of pedestrian sight lines on page 71.

Massing and Roof Form

Design new additions so that they do not visually overpower the existing building, compromise its historic character, or destroy any significant historic features or materials. Additions shall appear subordinate to the existing building.

- a. Design the addition to complement the scale, massing, and roof form of the original historic building. The massing of the addition shall respond to the massing of the original building.
 - i. For example, if the massing of the original building has step-backs as it rises in height, then it is appropriate for the addition to have a stepped massing. However, if the original building is a uniform shaft, then the addition shall not include step-backs.
 - ii. If the roof of the addition is visible from the public right-of-way, the roof form and pitch shall reflect the form and pitch of the roof on the original building.
- b. Minimize the appearance of the addition from the public right-of-way facing the front façade.
 - i. The building's overall shape as viewed from the street shall appear relatively unaltered.
 - ii. Whenever possible, additions shall be no wider than the original building.
 - iii. Design side additions to minimize visual impact and maintain the pattern of side setbacks on the street.

Appropriate Examples of Massing and Roof Forms on Additions to Residential Buildings



To accommodate the addition, the roof has been elevated slightly and a dormer window has been added, but the original roof form is maintained. The scale of the original building is maintained.



The addition is set back from the front façade and does not destroy or detract from character-defining features of the original building. The roof form from the original building is reflected in the roof form of the addition.



The addition is set back behind the original rear façade and does not destroy or detract from the character-defining features of the original building. The materials and windows used are in keeping with the original building.

Inappropriate Examples of Massing and Roof Forms on Additions to Residential Buildings



The addition is set forward flush with the front façade. The three-story scale overwhelms the original building. The roof form and fenestration pattern do not reflect the character of the original building.



Although the scale of the addition is small, the roof form does not reflect the character of the original building. Because the form of the original building is so simple, the addition visually competes with the original building.



The addition is set forward almost flush with the front façade of the original building. The flat roof is not compatible with the character of the original building. Modern or Contemporary design may be appropriate for an addition, provided that it is not visible from the street.

Issues with Additions to Residential Buildings



This addition is appropriate. It is minimal in scale, located at the rear, it does not overshadow the existing home, remove viewscapes, or impose privacy issues with adjacent neighbors. The addition is clearly identified as such and does not interfere with the historic section of the home. The addition is in scale with adjacent properties.



This addition is **inappropriate**. The second-story addition overshadows the original design intent and style of the one-story Bungalow Style house. The increase in square footage more than doubles the existing size of the home, creating a false sense of volume for the typical bungalow plan. The addition poses the potential to encroach on views of adjacent properties. The addition may be out of scale with adjacent properties if they are also one-story dwellings.



The addition at the left is in scale with the existing building. The addition in the example at the right overwhelms the existing house.

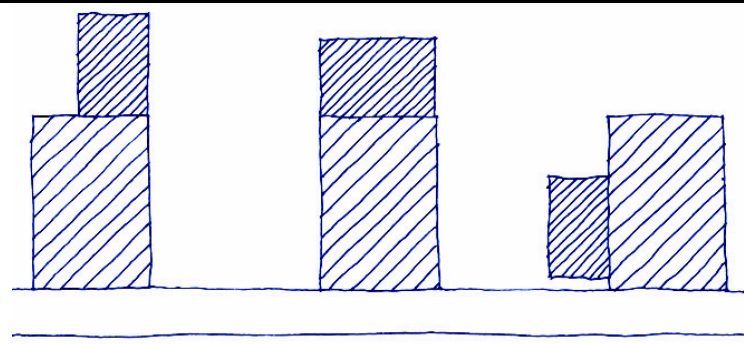

Avoid additions such as those on the far right—it is visible from the street.

(Source: City of New Orleans Historic District Landmarks Commission Guidelines for New Construction, Additions and Demolition.)

Appropriate Examples of Massing and Roof Forms on Additions to Commercial Buildings



The addition is barely visible when seen from the public right-of-way. When viewed from the rear, the addition is large in scale and uses contemporary design and materials, yet it is appropriate because it is hidden from view.



The façade of the multi-story rooftop addition is set back from the original façade, so that it is not visible from the public-right-of-way. The simple form and flat roof of the addition reflect the original building. (Source: National Park Service.)



Although the design of the addition is contemporary, the façade of the multi-story rooftop addition is set back from the original façade, so that it is not visible from the public-right-of-way.

Inappropriate Examples of Massing and Roof Forms on Additions to Commercial Buildings



The materials and color of the addition complement the original building, but it is set forward flush with the original façade, and the stepped-back massing is out of keeping with the compact massing of the original building.



The contemporary materials of the addition are incompatible with the original stone façade, the addition is set forward flush with the front façade, and the height of the addition overwhelms the original building.



The width of the addition extends beyond the original building and changes the overall massing of the building. The shed roof form does not reflect the design of the original building's parapet.



Although the flat roof form and contemporary style of the addition complement the original building, the addition is set forward flush with the original façade. The height and scale of the addition overwhelm the one-story original building.

Issues with Additions to Commercial Buildings

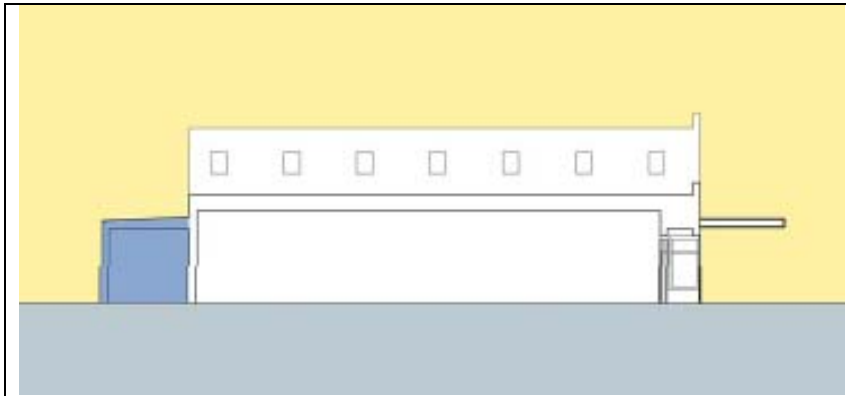

This addition is appropriate. It does not overshadow the existing property, is sensitive to the existing scale, and does not introduce an exaggerated sense of scale from what was present historically. Further the addition does not remove views or impose privacy issues with neighbors. Most importantly, it is not visible from the building's primary façade.



This addition is **not appropriate**. The large addition overshadows adjacent properties and is out of scale for the commercial district. The addition also diminishes the historic scale of the historic building and poses the potential to intrude on views from neighboring properties. Finally, the parapet—a character-defining feature of the original building—was removed.

(Source: City of New Orleans Historic District Landmarks Commission Guidelines for New Construction, Additions and Demolition.)

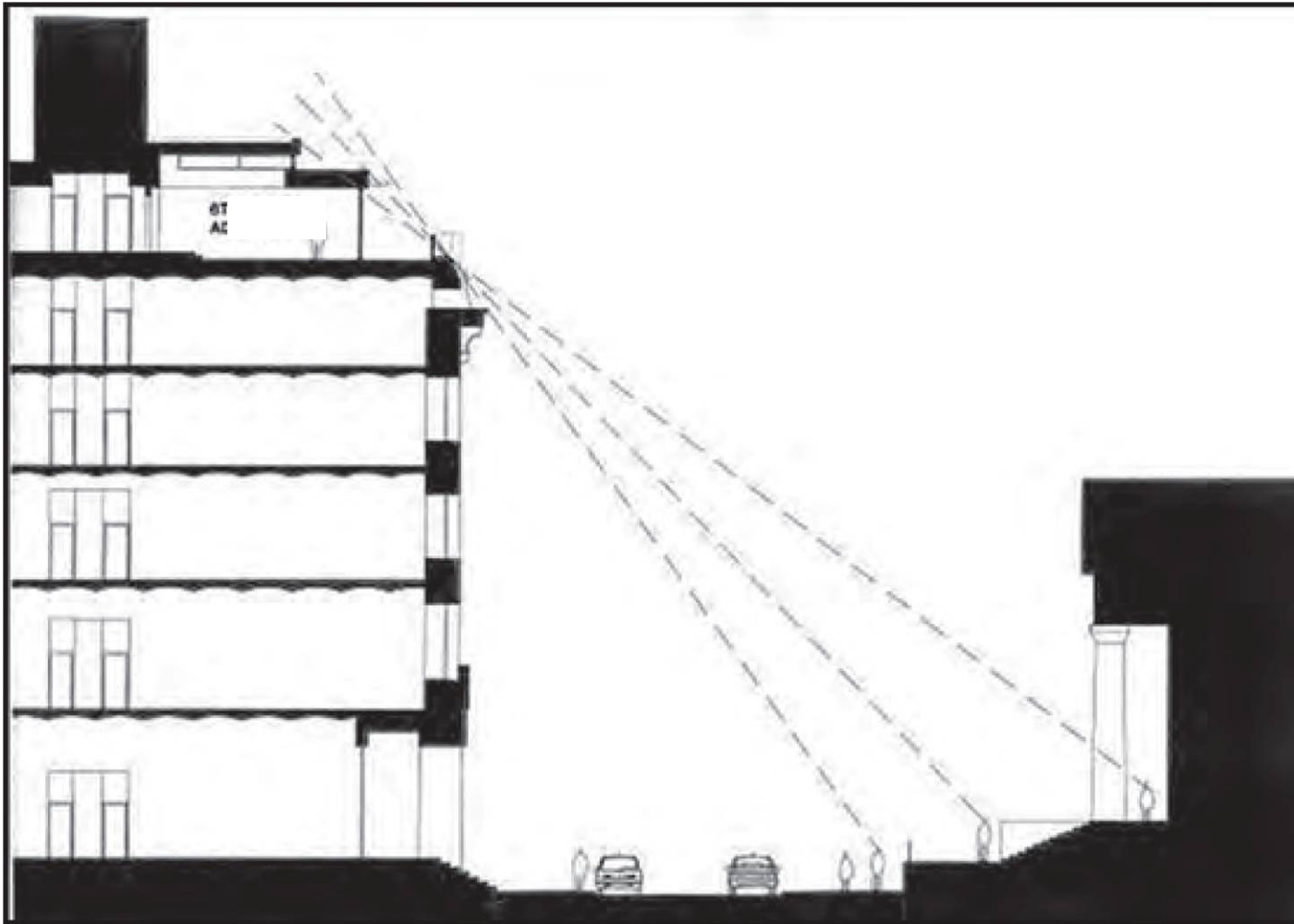

Illustration of pedestrian sight lines guiding the set back and height of a rooftop addition. (Source: National Park Service.)

Design and Style

- a. Additions shall be compatible with the historic building, but also differentiated so as not to give a false sense of history.
- b. Additions do not necessarily need to mimic the architectural style of the original historic building, and decorative details that may be confused as historic shall not be added. A contemporary design for an addition is appropriate when the addition is not visible from the street, or if the addition does not overwhelm or obliterate the historic building or its architectural features.
- c. If an addition will be visible from the street (either from the front or from the side), design the addition to complement the overall proportions and fenestration patterns of the original part of the building. For instance, additions that are visible from the street shall have window-to-wall area ratios, floor heights, fenestration patterns, and bay divisions compatible with those on the existing building.
- d. Avoid windowless walls unless they are a character-defining feature found on the original building.
- e. For buildings with a side-gabled or hipped original roof form, creation of usable upstairs space by constructing upstairs dormers on a side or back roof is appropriate provided that it does not affect the appearance of the building from the street. Dormers should be added only if they are appropriate for the original building form and style. Minimize the appearance of new dormers from the public right-of-way.

Exterior Walls

- a. If an addition will be visible from the street (either from the front or from the side), design the addition to complement the exterior wall materials of the original part of the building, as well as the collective character of a historic district.
- b. Differentiate the exterior wall materials of the addition from the existing building by means of a hyphen or joint using a

different material, varying trim boards, slightly varying dimension of materials, varying orientation of materials, or other means.

Roofs

- a. Whenever possible, the roof form of the new addition shall not be visible above the ridgeline of the original roof when the front of the building is viewed from the street.
- b. If visible from the street, an addition shall use a simple roof style and slope that complements the roof on the existing building.
- c. Use materials for the roof that match or are compatible with the roof on the existing building.
- d. Locate solar panels on the back of the roof whenever possible so that they are not visible from the street.

Windows and Screens

- a. If an addition will be visible from the street (either from the front or from the side), use windows that complement those on the existing building in terms of fenestration pattern, size, configuration, profile and finish.
- b. For windows on additions, avoid false muntins attached to or inserted between the glass in windows.
- c. Metal screens may be appropriate for windows in additions. Use anodized or coated metal screens to minimize their visual presence.

Doors

- a. If an addition will be visible from the street (either from the front or from the side), use doors that complement those on the existing building, yet are a simpler design so that they do not detract from the original main entrance.

NON-CONTRIBUTING BUILDINGS

- a. Alterations to a building that is non-contributing to a historic district because of its age or because it has received unsympathetic restorations shall be compatible with the architectural style of the building as well as the overall character of a historic district. The standards provided in the next section (*New Construction in Historic Districts*) for new construction may serve as a guide for alterations to noncontributing buildings.
- b. Alterations to historic non-contributing buildings are encouraged to attempt to return them to their historic appearance based upon physical or photographic evidence. The status of a non-contributing building in the Charpentier Historic District may be changed to contributing by amending the National Register nomination using the designation processes set forth by the Louisiana Division of Historic Preservation and the National Park Service.

NEW CONSTRUCTION IN CHARLESTOWN CULTURAL DISTRICT

New construction within the district shall reflect building forms, materials, massing, proportions, roof forms, fenestration patterns, and architectural styles historically present within the district. All current City of Lake Charles codes and ordinances regulating compatibility of new construction shall be followed. New construction in historic districts is specifically dealt with in the *City of Lake Charles Zoning Ordinance* at Article V, Part 3, Section 5-307. Downtown Development District owners, residents and contractors, as well as those in the western part of the Charpentier Historic District, should also consult the *Smart Code* for building restrictions and regulations (*City of Lake Charles Zoning Ordinance* at Article V, Part 3, Section 5-306).



Orientation, Set-backs and Height

- a. New or moved structures shall be positioned on their lot to maintain the existing patterns of the street.
- b. Front and side-yard setbacks shall equal the prevalent setback of the contributing buildings on the same side of the street. When the historic street pattern is irregular, new construction shall respond to an adjacent contributing property.
- c. The height of new construction shall respond to the streetscape and the dimensions of the lot. The height of new construction shall not exceed the height of the tallest contributing building on a similarly sized lot on the block.
- d. New construction shall respect adjacent properties and conform to all City of Lake Charles Zoning and Building codes.

Design and Style

- a. Quality of construction and materials shall always be prioritized over applied stylistic detailing.
- b. Design new buildings so that they are compatible with the historic character of the district, yet discernible from historic buildings in the district.
- c. The building forms and architectural styles that historically were present within the district may serve as a model for new construction. Refer to the inventory of historic properties and the *Architectural Character* section of these design guidelines to determine which building types and styles historically were present within the district. Historical styles that were not present during the district's period of significance shall not be used as a basis for new construction.
- d. Contemporary design and style is appropriate for new construction in the historic district if the building respects the scale, massing, proportions, patterns, and materials prevalent among contributing buildings within the district.
- e. It may be appropriate to incorporate compatible architectural features from existing buildings on the street, such as columns or transoms, but avoid architectural features that do not appear on contributing buildings in the district.
- f. Character-defining features from different architectural styles shall not be combined eclectically unless such eclectic buildings were prevalent in the district historically.

Issues for New Construction in a Residential Historic District

 <p>Example <i>may be appropriate, depending on surrounding context.</i> The front-gabled porch and complex massing of the building reflect patterns found in many historic districts, but not all. The scale is appropriate for areas of the Charpentier Historic District that includes large-scale original buildings.</p>	 <p>Example <i>may be appropriate, depending on surrounding context.</i> Modern or Contemporary design may be appropriate for districts that include historic examples of these styles, or for districts with a very eclectic character. The scale of the building may be too large for some historic districts.</p>	 <p><i>Inappropriate.</i> Projecting front garages typically are not consistent with the building forms found in residential historic areas of the Charlestown Cultural District.</p>
--	--	--



(Source: City of New Orleans Historic District Landmarks Commission Guidelines for New Construction, Additions and Demolition.)

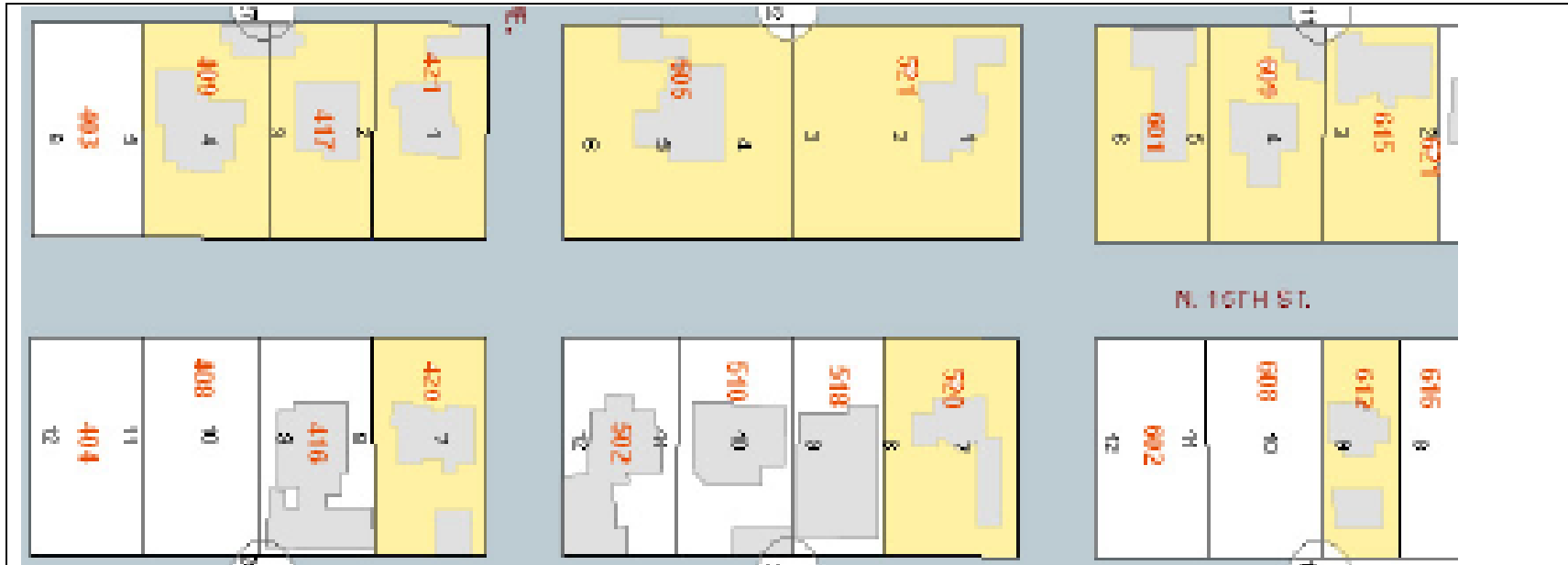

The highlighted properties exhibit similar setbacks and the same percentage of siting on the overall lot to maintain consistency in the district.

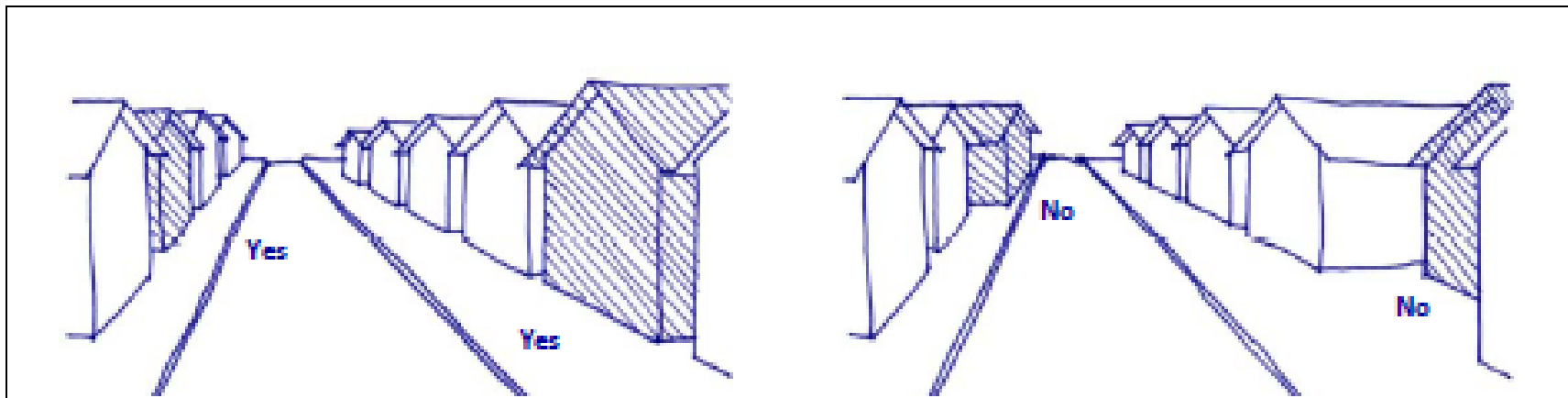

The prevailing setbacks should be maintained by new construction.

(Source: City of New Orleans Historic District Landmarks Commission Guidelines for New Construction, Additions and Demolition.)

Issues for New Construction in a Commercial Historic District



Appropriate. The height of the new building is in keeping with historic buildings, and the materials and storefront patterns reflect adjacent buildings. The large scale of the new building is broken up by variations in the height of the parapet and the depth of the front façade.



Appropriate. The height of the new building is in keeping with historic buildings, and the materials and storefront patterns reflect adjacent buildings.



Inappropriate. The contemporary, metal and glass skyscraper does not reflect the scale, massing, or materials of adjacent historic buildings.

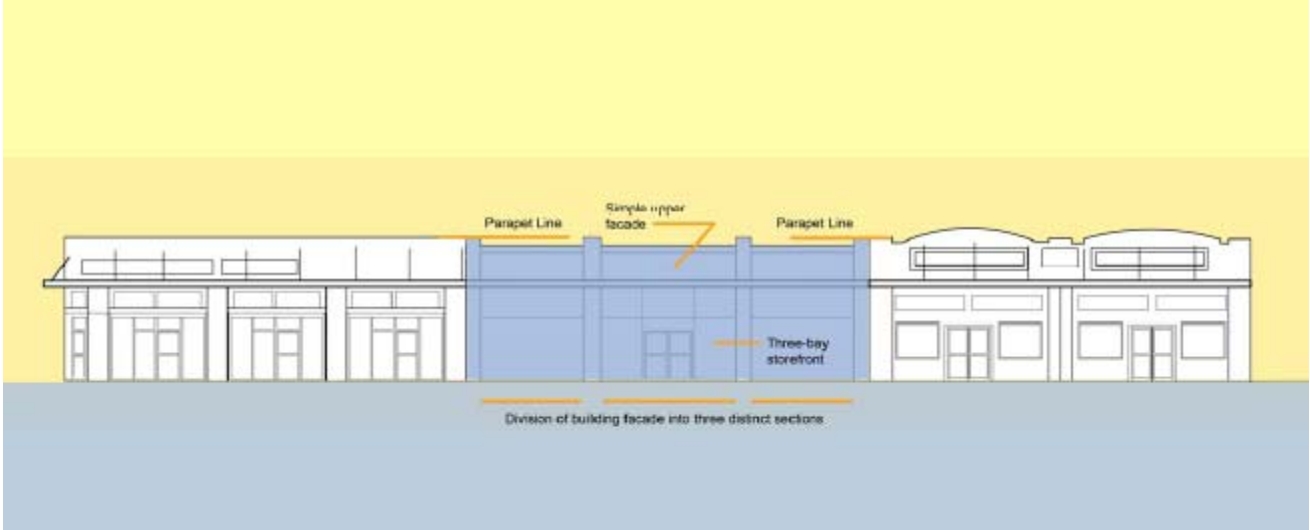

This new building is appropriate. It maintains the scale of the district. The one-story building form is adjacent to historic one-story buildings and has consistent vertical and horizontal divisions.



This diagram illustrates the maintenance of appropriate setbacks in a commercial district. The areas highlighted in blue show the appropriate location for additions and parking.

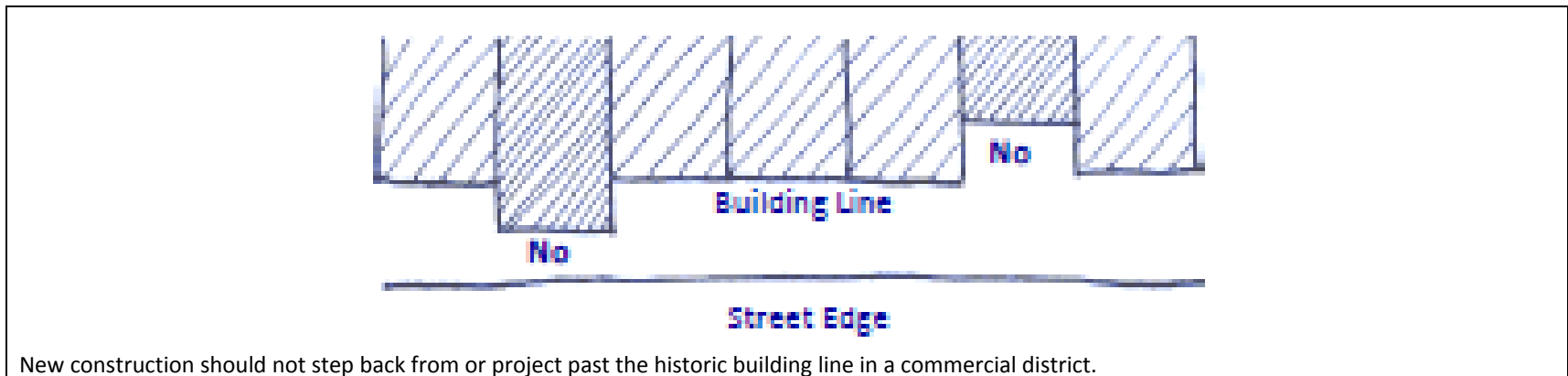

New construction should not step back from or project past the historic building line in a commercial district.

(Source: City of New Orleans Historic District Landmarks Commission Guidelines for New Construction, Additions and Demolition .)

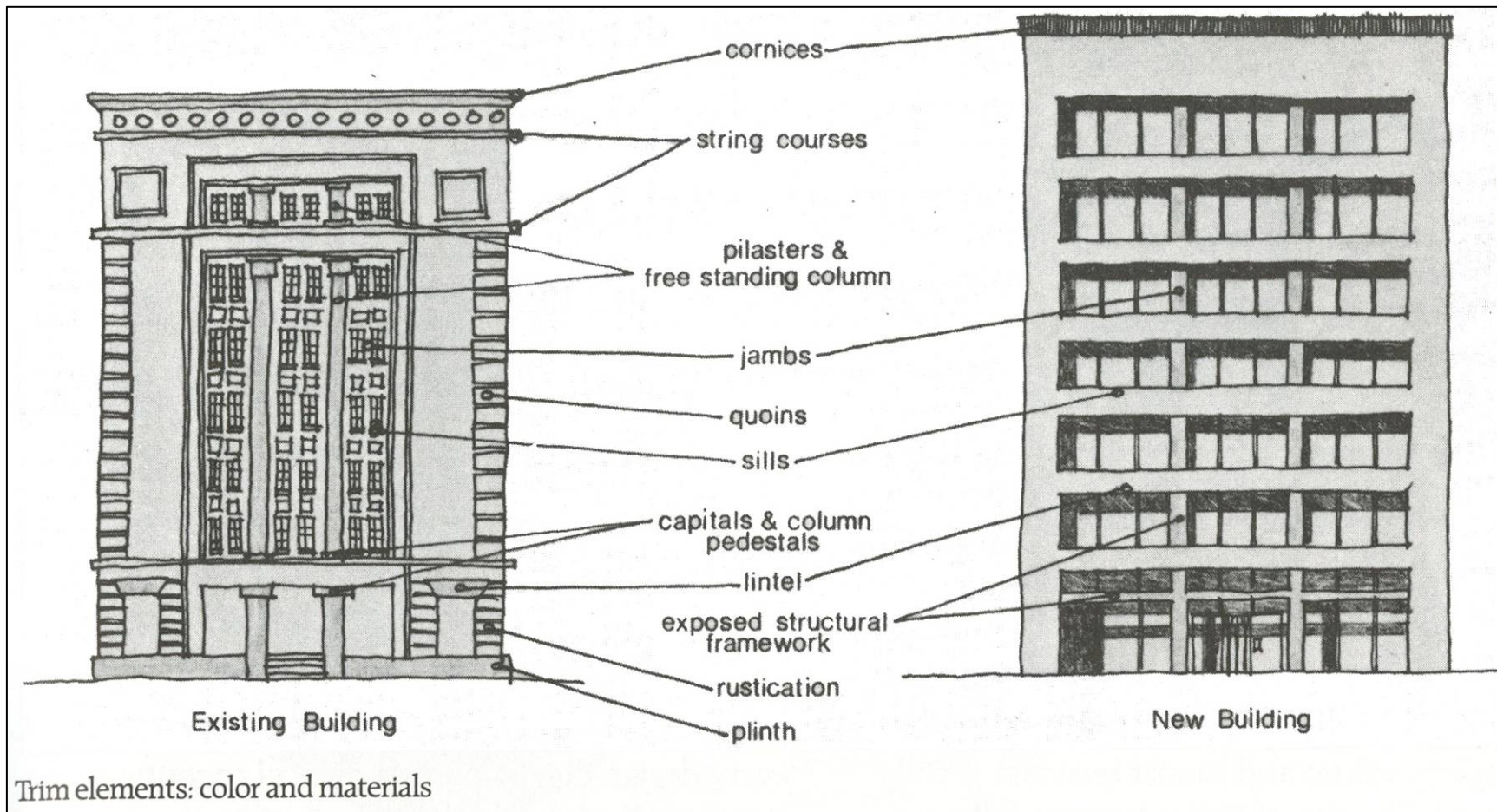

Illustration of the elements of a historic commercial building compared to an appropriate new commercial building. (Source: National Trust for Historic Preservation.)

Exterior Walls

- a. Exterior wall materials used in new construction shall be compatible with the collective character of the district in scale, type, size, finish, and texture.
- b. The pattern and arrangement of secondary materials shall be compatible with the overall character of the district.
- c. Exterior materials shall correspond to the building form and architectural style of the new building in a way that responds to historical trends. Refer to the *Architectural Character* section of these design guidelines.

Porches

- a. If porches are a common character-defining feature among contributing buildings within the district, new construction is encouraged to have a front porch. If all of the contributing buildings immediately surrounding the new building include porches, then the new building shall include a porch.
- b. Porch posts/columns, railings, and detailing shall correspond to the building form and architectural style of the new building in a way that responds to historical trends. Refer to the *Architectural Character* section of these design guidelines for further details.
- c. In general, do not add false historical architectural elements, such as brackets or gingerbread, to a new porch. The HPC may approve exceptions to this standard if the overall design of the new building accurately interprets the appearance of a historical style present within the district.

Roofs

- a. Roofs shall be simple in form, reflecting the character of the roofs on contributing buildings within the district.
- b. Roof forms shall correspond to the building form and architectural style of the new building in a way that responds

- c. to historical trends. Refer to the *Architectural Character* section for further details.
- c. Roof details such as dormers, eave detailing, and bargeboards shall correspond to the building form and architectural style of the new building in a way that responds to historical trends. Refer to the *Architectural Character* section for further details.
- d. Roof covering materials shall reflect the character of the roofs on contributing buildings within the district, as well as the historic character of buildings with a similar building form and architectural style.

Windows and Screens

- a. Windows and screens in new construction shall reflect the proportions, configuration, and patterns of the windows and doors that they cover in historic buildings within the district.
- b. Windows and screens in new construction shall correspond to the building form and architectural style of the new building in a way that responds to historical trends. Refer to the *Architectural Character* section of these design guidelines for further details.
- c. Avoid false muntins attached to or inserted between the glass panes in windows.

Doors

- a. Front doors shall be visible from the street.
- b. Match the style, proportions, materials, and finish of the door to the overall style and design of the building.

Chimneys

- a. Chimneys in new construction shall reflect the configuration and patterns of chimneys in historic buildings within the district.

- b. Chimneys in new construction shall correspond to the building form and architectural style of the new building in a way that responds to historical trends. Refer to the *Architectural Character* section of these design guidelines for further details.

Garages and Accessory Buildings

- a. Locate detached garages and accessory buildings at the side or rear of new residential structures within the district.
- b. Design garages and accessory buildings so that their scale is compatible with the associated main building, and so that they have an appropriate site relation to the main structure as well as surrounding structures.
- c. Garages shall be attached only if attached garages historically were appropriate to the building form and architectural style of the new construction. For instance, an attached garage may be appropriate on a new building with a Ranch form, but not a new building with a center-passage form. Refer to the *Architectural Character* section of these design guidelines for more information.
- d. The materials and finish used for new garages and outbuildings, including garage doors, shall correspond to the overall character of the district, as well as the building type and style of the new building

Independent Fences and Walls

- a. Avoid constructing new walls where they were not historically present on the lot or within the historic district.

- b. Fences and walls may not obscure the front elevation of the primary structure on the property.
- c. Fence materials, scale, and finish shall reflect historic trends visible on other contributing buildings within the district.

Landscaping

- a. Attempt to preserve existing trees.
- b. Do not obscure the front or primary façade of the building with vegetation.
- c. When constructing a two-story new building or rear addition, consider the use of vegetative screening at the back and side property lines to diminish the visibility of the new construction and respect the privacy of your property and that of your neighbors.
- d. Within a historic district, surface parking lots shall not be constructed between the front façade of a new building and the public right-of-way. If a surface parking lot is constructed on an empty lot or at the rear or side of a new building, vegetative screening shall shield the view of the parking lot from the public right-of-way, if appropriate.
- e. When constructing new landscape or streetscape features in a historic district, follow patterns established elsewhere in the district. For instance, when new sidewalks are constructed, expansion, control, and construction joints should be spaced and located so as to relate to the existing divisions and proportions of the existing sidewalks.

RELOCATION AND DEMOLITION IN THE CHARLESTOWN CULTURAL DISTRICT

The demolition or relocation of a contributing building or structure in the Charlestown Cultural District is strongly discouraged and is only considered as a last resort.

Relocation constitutes moving a building or structure from its original location.

Demolition constitutes the complete destruction of a historic resource. The HPC reviews applications for the demolition of buildings, structures, sites, and trees older than 50 years of age in the historic district. Demolition of an individual resource alters the character of the district since its design, texture, materials, and place in the neighborhood cannot be replaced.

Regulations for relocation and demolition are provided for the Charpentier Historic District. The City Planning Department should be contacted for regulations regarding relocation and demolition in the Downtown Development District.

Charpentier Historic District Regulations

Demolition and relocation are considered as Major Work projects and require the approval of the HPC.

Relocation

The HPC's decision for approving or denying a COA for relocation is based on the following standards:

1. Whether the structure is endangered in its original location. Relocation should not be considered without first meeting this standard;
2. The historic character and aesthetic interest the building, structure, or object contributes to its present setting;

3. Whether there are definite plans for the area to be vacated and what the effect of those plans on the character of the surrounding area will be;
4. Whether the building, structure or object can be moved without significant damage to its physical integrity; and
5. Whether the proposed location area is compatible with the historical and architectural character of the building, structure, site, or object.

Demolition

The HPC's decision for approving or denying a COA for demolition is based on the following standards:

1. The historic, scenic, or architectural significance of the building, structure, site, tree, or object;
2. The importance of the building, structure, site, tree or object to the ambience of the district;
3. The difficulty of the impossibility of reproducing such a building, structure, site, tree or object because of its design, texture, material, detail, or unique location;
4. Whether the building, structure, site, tree or object is one of the last remaining examples of its kind in the neighborhood or city;
5. Whether there are definite plans for use of the property if the proposed demolition is carried out, and what the effect of those plans on the character of the surrounding area would be;
6. Whether reasonable measures can be taken to save the building, structure, site, tree or object from collapse; and
7. Whether the building, structure, site, tree or object is capable of earning reasonable economic return on its value.

A COA for demolition will not be issued unless the applicant has demonstrated that:

1. It is not economically feasible to maintain the structure;
2. The applicant has explored preservation options, such as the sale of the resource to an individual or group interested in preserving it;
3. The applicant has posted on the premises of the property, in a manner easily visible from the public way, notice of intended demolition for a period of six months prior to application for a COA; and,
4. The applicant has sought and been denied a conditional use permit for an alternate use, pursuant to Section 5-307(10) of the historic preservation ordinance.

Demolition by Neglect

No owner or person with an interest in real property designated as a landmark or included in the Charlestown Cultural District shall permit the property to fall into a serious state of disrepair so as to result in the deterioration of any exterior architectural feature which would, in the judgment of the HPC, produce a detrimental effect upon the character of the historic district as a whole or the life and character of the property itself.

Examples of such deterioration include, but are not limited to:

- deterioration of exterior walls or other vertical supports;
- deterioration of roof or other horizontal members;
- deterioration of exterior chimneys;
- deterioration or crumbling of exterior stucco or mortar;
- ineffective waterproofing of exterior walls, roof, or foundations, including broken windows or doors;

- deterioration of any feature so as to create a hazardous condition which could lead to the claim that demolition is necessary for the public safety.

Demolition by neglect will bar a property owner from raising an economic hardship claim.

Applications for Relocation or Demolition

COA applications for relocation or demolition shall include:

- information regarding the condition of the structure;
- estimated cost of restoration or repair;
- demonstration that the adaptive use or restoration of the structure has been seriously considered;
- any available historic records of the building (drawings, photographs, etc.);
- architectural drawings for any proposed new constructions which are intended to replace the historic resource;
- demonstration that the applicant has made a serious attempt for six months to sell the resource, at market value through a multiple listing agency, to an individual or group who would restore the property on site; and
- any other information that the staff finds appropriate for the HPC to render a decision on the application.

All of the above components must be submitted for a COA application for demolition or relocation to be considered complete and for the Director of Planning to forward it to the HPC.

APPENDIX A: GLOSSARY

Abut

To adjoin at an end; to be contiguous.

Arch

A curved and sometimes pointed structural member used to span an opening.

Awning

A projecting roof-like structure sheltering a door or window, often canvas.

Balcony

A railed projecting platform found above ground level on a building.

Bargeboard

A board, sometimes decorative, that adorns the gable-end of a gabled roof.

Battered Foundation

A foundation that is inclined, so that it appears to slope inward as it rises upward.

Bead Board

Wood paneling with grooves.

Board and Batten

Wood siding with wide boards, placed vertically, and narrow strips of wood (battens) covering the seams between the boards.

Boxed Eaves

Eaves that are enclosed with a fascia and panels under the soffit.

Bracket

A projecting support used under cornices, eaves, balconies, or windows to provide structural or visual support.

Brick

A building or paving unit made of fired clay, usually rectangular in shape.

Canopy

A projection over a niche or doorway; often decorative or decorated.

Capital

The uppermost part, or head, of a column or pilaster.

Casement Window

A window sash that swings open along its entire length; usually on hinges fixed to the sides of the opening into which it is fitted.

Column

A round, vertical support; in classical architecture, the column has three parts, base, shaft, and capital.

Concrete Block

A hollow or solid concrete masonry unit consisting of cement and suitable aggregates combined with water.

Concrete Slab

A flat, rectangular, reinforced concrete structural member; especially used for floors and roofs.

Concrete

Made by mixing cement or mortar with water and various aggregates such as sand, gravel, or pebbles.

Contributing

A building, site, structure, or object within a historic district that adds to the values or qualities of that district because it was present during the period of significance and possesses historical integrity, or it independently meets NRHP Criteria.

Coping

The protective uppermost course of a wall or parapet.

Corbelling

Pattern in a masonry wall formed by projecting or overhanging masonry units.

Cornice

A projecting, ornamental molding along the top of a building, wall, etc., finishing or crowning it.

Crenelation

A parapet with alternating solid and void spaces, originally used for defense; also known as battlement.

Dormer

A vertically set window on a sloping roof; also the roofed structure housing such a window.

Dentils

A series of closely spaced, small, rectangular blocks, used especially in classical architecture.

Double-Hung Window

A window of two (or more) sash, or glazed frames, set in vertically grooved frames and capable of being raised or lowered independently of each other.

Eaves

The lower edges of a roof that projects beyond the building wall.

Engaged Column

A column that is partially attached to a wall.

Eyebrow Dormer

A low dormer with a wavy line over the lintel, resembling an eyebrow.

Façade

An exterior wall.

Fanlight

An arched window with muntins that radiate like a fan; typically used as a transom.

Fenestration

An opening in a surface.

Fixed Sash

A window, or part of a window, that does not open.

Flat Roof

A roof that has only enough pitch so that water can drain.

Gabled Roof

A roof having a single slope on each side of a central ridge; usually with a gable at one or at both ends of the roof.

Gambrel Roof

A roof having a double slope on two sides of a building; the most common example is a barn roof.

Half-Timbered

Heavy timber framing with the spaces filled in with plaster or masonry.

Hipped Roof

A roof having adjacent flat surfaces that slope upward from all sides of the perimeter of the building.

Historic District

A concentrated and cohesive grouping of historic resources that retain a significant amount of their historic character; historic resources that add to the district's overall sense of time and place are classified as Contributing elements; severely altered historic properties and resources of more recent construction are classified as non-contributing elements.

Hood

A protective and sometimes decorative cover over doors, windows, or chimneys.

Integrity

Condition or description of a property that is physically unaltered or one that retains enough of its historic character, appearance, or ambiance to be recognizable to the period when the property achieved significance.

Jalousie Window

A window composed of angled, overlapping slats of glass, arranged horizontally like a shutter in order to tilt open for ventilation.

Leaded Glass Window

A window composed of pieces of glass that are held in place with lead strips; the glass can be clear, colored, or stained.

Lintel

The piece of timber, stone, or metal that spans above an opening and supports the weight of the wall above it.

Lites

Window panes.

Mansard Roof

A roof having two slopes on all four sides; the lower slope is much steeper than the upper.

Mortar

A mixture of cement, lime, sand, or other aggregates with water; used in plastering and bricklaying.

Masonry

A construction method that stacks masonry units, such as stones or bricks, and binds them with mortar to form a wall.

Mullion

A large vertical member separating two casements or coupled windows or doors.

Muntin

One of the thin strips of wood used to separate panes of glass within a window.

Non-Contributing

A building, site, structure, or object within an historic district that does not add to the values or qualities of that district because it was not present during the period of significance or because it no longer retains integrity.

Paneled Door

A door constructed with recessed rectangular panels surrounded by raised mouldings.

Parapet

A low wall or protective railing, usually used around the edge of a roof or around a balcony.

Pediment

A triangular section framed by a horizontal moulding on its base and two sloping mouldings on each side.

Pier and Beam Foundation

Foundation consisting of vertical piers that support horizontal beams.

Pilaster

A rectangular column or shallow pier attached to a wall.

Porch

A covered entrance or semi-enclosed space projecting from the façade of a building; may be open sided, screened, or glass enclosed.

Porte Cochere

A roofed structure attached to a building and extending over a driveway, allowing vehicles to pass through.

Preservation

The act or process of applying measures to sustain the existing form, integrity, or material of a building or structure; the NHPA, Section 303[8] defines the term as “identification, evaluation, recordation, documentation, curation, acquisition, protection, management, rehabilitation, restoration, stabilization, maintenance, research, interpretation, conservation, and education and training regarding the foregoing activities or any combination of the foregoing activities.”

Pyramidal Roof

A pyramid-shaped roof with four sides of equal slope and shape.

Quoins

Large or rusticated stone blocks at the corners of a masonry building.

Rafter

One of a series of structural members spanning from the ridge of the roof to the eaves, providing support for the covering of a roof.

Reconstruction

Treatment that “establishes limited opportunities to recreate a non-surviving site, landscape, building, structure, or object in all new materials.”

Rehabilitation

The act or process of returning a cultural resource to a state of utility through repair or alteration that makes possible an efficient, contemporary use while preserving those portions or features of the property that are significant to its historical, architectural, or cultural values.

Restoration

The act or process of accurately recovering the form and details of a property and its setting as it appeared at a particular time by means of the removal of later work or by the replacement of missing earlier work.

Repointing

The act of repairing the joints of brickwork, masonry, etc., with mortar or cement.

Shed Roof

A roof containing only one sloping plane.

Side Light

A vertical window flanking a door.

Side-Gabled Roof

A gable whose face is on one side (or part of one side) of a house, perpendicular to the façade.

Sill

Horizontal member at the bottom of a window or door opening.

Soffit

The underside of an overhanging element, such as the eaves of a roof.

Storm Window

A secondary window installed to protect and/or reinforce the main window.

Stucco

Exterior finish material composed of either Portland cement or lime and sand mixed with water.

Transom

A horizontal window over a door or window.

Wing Wall

A portion of the front façade extending past the side façade, often sloping down from the eaves to the ground at an angle; a subordinate wall, one end of which is built against an abutment.

APPENDIX B: MAP OF CHARLESTOWN CULTURAL DISTRICT

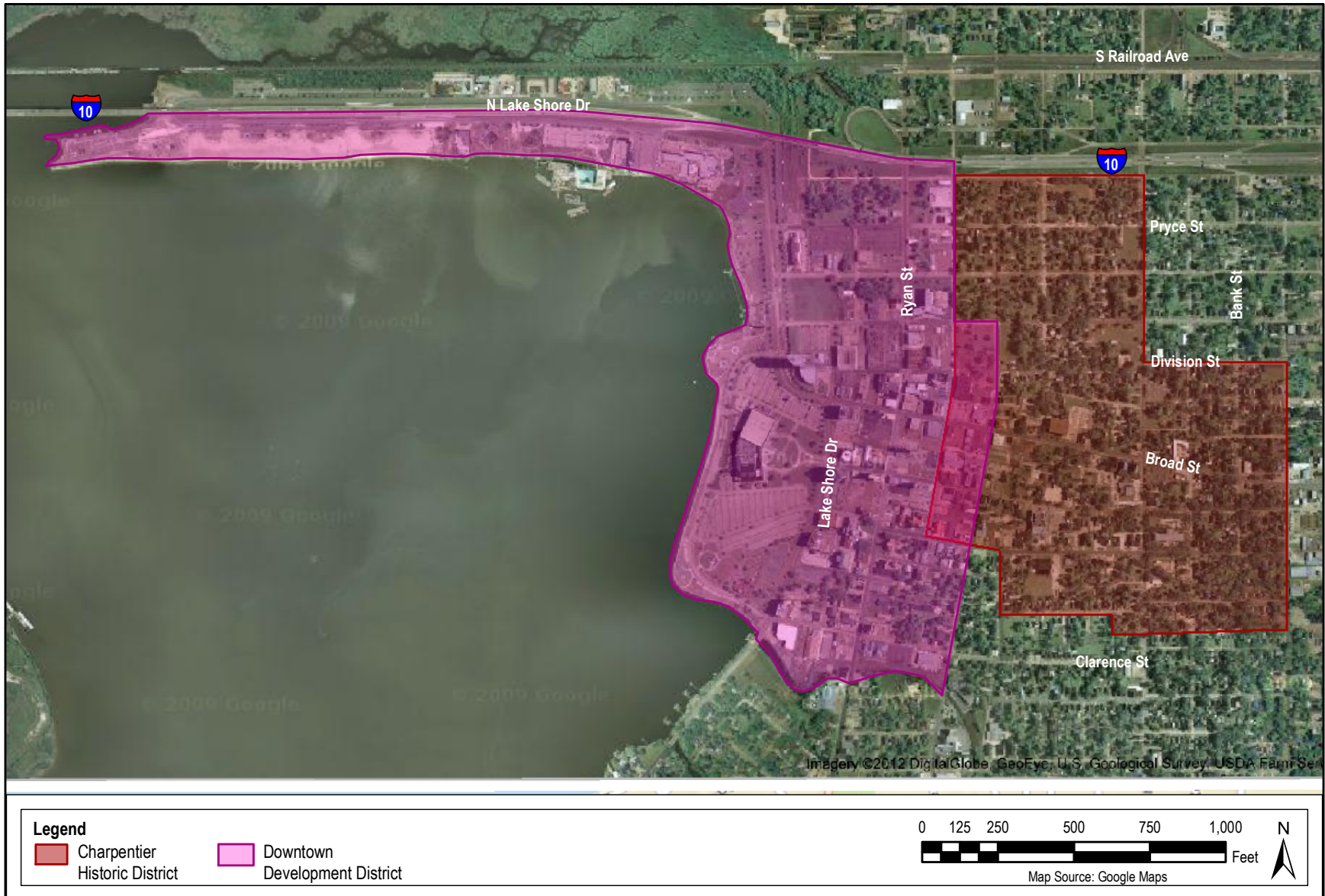

APPENDIX C: MAP OF CHARPENTIER HISTORIC DISTRICT

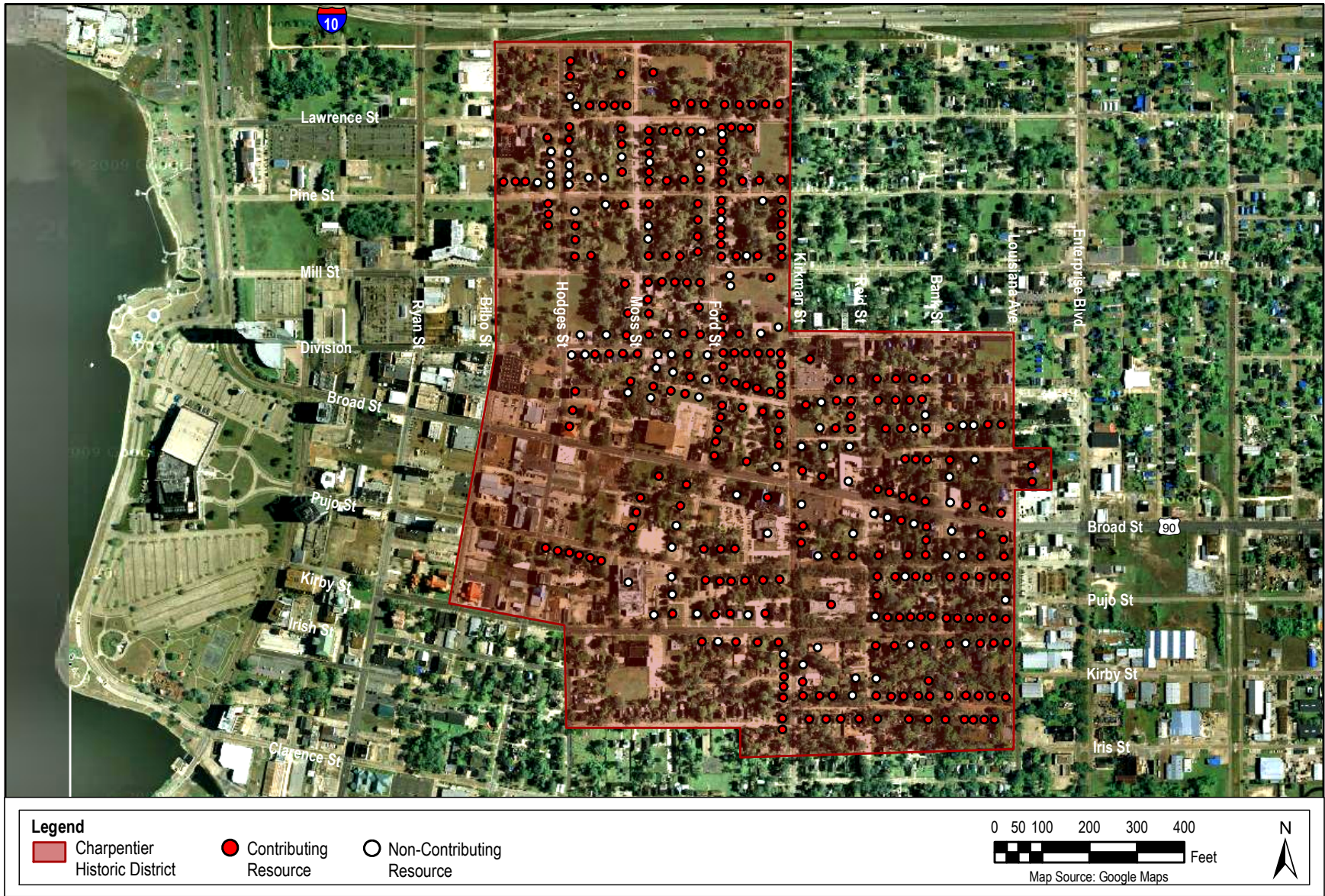

APPENDIX C: MAP OF CHARPENTIER HISTORIC DISTRICT



Charpentier Historical District

0 100 200 400 Feet

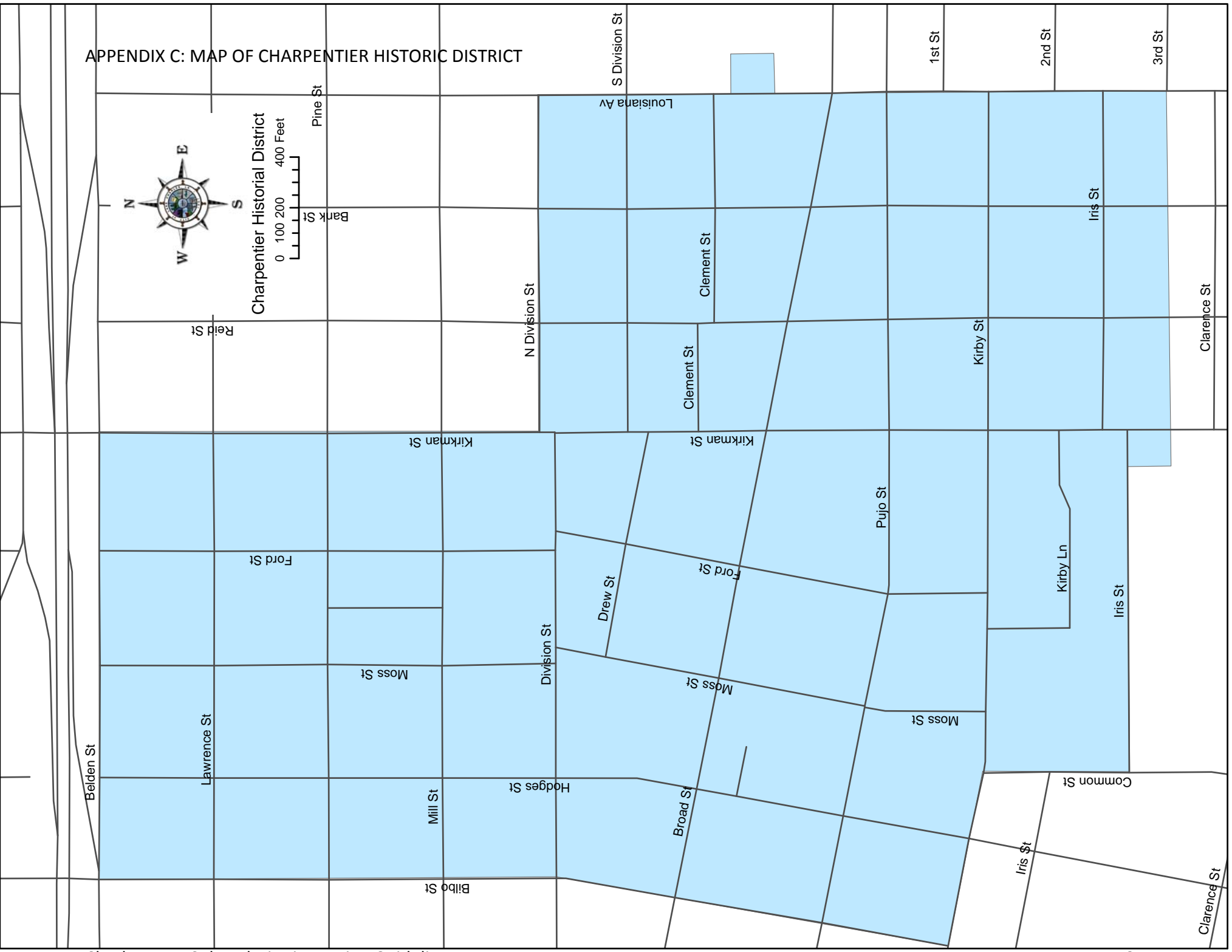

APPENDIX D: INVENTORY OF CHARPENTIER HISTORIC DISTRICT AND CALCASIEU HISTORICAL PRESERVATION SOCIETY LANDMARKS (AS OF JANUARY 2012)

Inventory of Charpentier Historic District

Address	Date	Contributing/ Non-contributing Status	Historic Name	Calcasieu Historical Preservation Society Landmark
727 Lawrence	1920	Contributing		
725 Lawrence	1915	Contributing		
721 Lawrence	1915	Contributing		
710 Lawrence	1920	Contributing		
709 Lawrence	1930	Contributing		
706 Lawrence	1920	Contributing		
700 block Lawrence	1910	Contributing		
702 Lawrence	1920	Contributing		
630 Lawrence		Non-contributing		
629 Lawrence	1890	Contributing		
622 Lawrence	1920	Contributing		
621 Lawrence	1920	Contributing		
600 block Lawrence	1920	Contributing		
619 Lawrence	1890	Contributing		
618 Lawrence	1920	Contributing		
606 Lawrence	1920	Contributing		
530 Lawrence	1905	Contributing	Edward Richards House	X
521 Lawrence		Non-contributing		
520 Lawrence	1930	Contributing		
518 Lawrence	1920	Contributing		
517 Lawrence	1920	Contributing		
516 Lawrence	1920	Contributing		
515 Lawrence	1905	Contributing		
503 Lawrence		Non-contributing		

Address	Date	Contributing/ Non-contributing Status	Historic Name	Calcasieu Historical Preservation Society Landmark
727 Pine	1900	Contributing	Charles F. Miller-George R. Foster House	X
700 block Pine		Non-contributing		
721 Pine	1900	Contributing		
719 Pine	1900	Contributing		
627 Pine	1920	Contributing		
617 Pine	1920	Contributing		
615 Pine	1920	Contributing		
		Non-contributing		
500 block Pine		Non-contributing		
511 Pine		Non-contributing		
505 Pine		Non-contributing		
423 Pine		Non-contributing		
419 Pine	1930	Contributing		
411 Pine	1890	Contributing		
401 Pine	1890	Contributing	Perkins-Duhon House	X
721 Mill	1900	Contributing		
715 Mill	1920	Contributing		
711 Mill		Non-contributing		
707 Mill	1910	Contributing		
703 Mill	1910	Contributing		
628 Mill	1915	Contributing		
625 Mill	1920	Contributing		
618 Mill	1920	Contributing		
617 Mill	1920	Contributing		
614 Mill	1920	Contributing		
610 Mill	1920	Contributing		
605 Mill	1900	Contributing	Flanders House	X
530 Mill	1910	Contributing		
515 Mill	1920	Contributing		

Address	Date	Contributing/ Non-contributing Status	Historic Name	Calcasieu Historical Preservation Society Landmark
503 Mill	1890	Contributing		
712 Division	1920	Contributing	Neil J. Bryan House	X
716 Division	1920	Contributing		
700 block Division		Non-contributing		
714 Division	1920	Contributing	Louis Z. Kushner House	X
712 Division	1920	Contributing		
107 Division	1930	Contributing		
704 Division	1930	Contributing		
705 Division	1930	Contributing		
702 Division	1920	Contributing		
628 Division	1920	Contributing		
625 Division	1890	Contributing		
625 Division		Non-contributing		
613 Division		Non-contributing		
606 Division		Non-contributing		
601 Division	1890	Contributing		
528 Division	1920	Contributing		
527 Division	1890	Contributing		
522 Division	1920	Contributing		
518 Division	1890	Contributing		
500 block Division		Non-contributing		
514 Division	1905	Contributing		
500 block Division		Non-contributing		
Corner Division and Hodges		Non-contributing		
928 South Division	1915	Contributing		
923 South Division	1890	Contributing		
917 South Division	1890	Contributing	Beatty-Ponton House	X
912 South Division	1920	Contributing		
900 block South Division	1920	Contributing		

Address	Date	Contributing/ Non-contributing Status	Historic Name	Calcasieu Historical Preservation Society Landmark
907 South Division	1890	Contributing	H. B. Mulligan-Ida Winter Clarke House	X
902 South Division	1922	Contributing	Opal Hughes Gray House	X
901 South Division	1910	Contributing	Judge Winston Overton House	X
800 block South Division	1925	Contributing		
825 South Division	1900	Contributing	Dr. John Greene Martin House	X
821 South Division	1890	Contributing		
820 South Division	192?	Contributing		
806 South Division		Contributing		
800 block South Division		Non-contributing		
718 Drew	1920	Contributing		
713 Drew	1920	Contributing		
711 Drew	1920	Contributing		
712 Drew	1930	Contributing		
709 Drew	1920	Contributing		
705 Drew	1920	Contributing		
703 Drew	1920	Contributing		
629 Drew		Non-contributing		
623 Drew	1890	Contributing		
622 Drew		Non-contributing		
619 Drew		Non-contributing		
618 Drew	1920	Contributing		
614 Drew	1920	Contributing		
1000 block Clement	1900	Contributing		
1000 block Clement	1900	Contributing		
1010 Clement		Non-contributing		
1009 Clement		Non-contributing		
1000 block Clement		Non-contributing		

Address	Date	Contributing/ Non-contributing Status	Historic Name	Calcasieu Historical Preservation Society Landmark
1001 Clement	1920	Contributing		
921 Clement	1900	Contributing		
917 Clement		Non-contributing		
916 Clement	1930	Contributing		
913 Clement	1900	Contributing		
900 block Clement	1920	Contributing		
909 Clement	1890	Contributing		
828 Clement	1950	Non-contributing		
821 Clement	1920	Contributing		
806 Clement	1900	Non-contributing		
800 block Clement	1940	Non-contributing		
1000 block Broad	1920	Contributing		
1025 Broad	1930	Contributing		
1012 Broad	1920	Contributing		
1000 block Broad	1930	Contributing		
1015 Broad	1920	Contributing		
1004 Broad	1940	Non-contributing		
1005 Broad		Non-contributing		
924 Broad	1930	Contributing		
929 Broad	1910	Contributing	Fred Lock House	X
920 Broad		Non-contributing		
919 Broad	1920	Contributing		
917 Broad	1920	Contributing		
916 Broad	1915	Contributing		
914 Broad		Non-contributing		
900 block Broad	1905	Contributing		
900 Broad	1940	Non-contributing		
903 Broad	1915	Contributing	Chester Brown House	X
800 block Broad		Non-contributing		
815 Broad	1930	Contributing		

Address	Date	Contributing/ Non-contributing Status	Historic Name	Calcasieu Historical Preservation Society Landmark
800 block Broad		Non-contributing		
803 Broad	1920	Contributing		
812 Kirkman Corner Broad and Kirkman	1920	Contributing	First United Methodist Church	X
		Non-contributing		
723 Broad	1905	Contributing	Wachsen-Williams House	X
705 Broad	1885	Contributing		
626 Broad	1885	Contributing	Ramsey-Gayle House	X
616 Broad	1930	Contributing		
1030 Pujo	1905	Contributing		
1025 Pujo	1920	Contributing		
1024 Pujo	1920	Contributing		
1015 Pujo	1920	Contributing		
1020 Pujo	1920	Contributing		
1018 Pujo	1920	Contributing	Edgar Miller House	X
1013 Pujo		Non-contributing		
1004 Pujo	1910	Contributing	Arthur Gayle House	X
1000 block Pujo		Non-contributing		
930 Pujo	1915	Contributing	Blanche M. Mitchell House	X
919 Pujo	1890	Contributing	Abraham Christman House	X
917 Pujo	1920	Contributing		
914 Pujo	1915	Contributing		
912 Pujo		Non-contributing	A. Leopold Kaufman House	X
902 Pujo	1920	Contributing		
905 Pujo	1915	Contributing		
900 Pujo	1920	Contributing		
827 Pujo	1890	Contributing		
819 Pujo	1920	Contributing		
811 Pujo		Non-contributing		

Address	Date	Contributing/ Non-contributing Status	Historic Name	Calcasieu Historical Preservation Society Landmark
742 Pujo	1910	Contributing	Samuel Thomas Woodring House	X
736 Pujo	1910	Contributing		
728 Pujo	1890	Contributing		
700 block Pujo	1920	Contributing		
722 Pujo	1890	Contributing		
717 Pujo	1900	Contributing		
714 Pujo	1910	Contributing		
711 Pujo	1920	Contributing		
703 Pujo	1900	Contributing	Frank Roberts House	X
700 Pujo		Non-contributing		
628 Pujo		Non-contributing		
		Non-contributing		
603 Pujo	1890	Contributing	Fannie H. Quilty House	X
500 block Pujo	1900	Contributing		
518 Pujo	1910	Contributing	Dominic-Schindler House	X
512 Pujo	1890	Contributing		
500 block Pujo	1920	Contributing		
508 Pujo	1880	Contributing		
504 Pujo	1915	Contributing		
1028 Kirby	1920	Contributing		
1029 Kirby	1900	Contributing		
1026 Kirby	1915	Contributing		
1025 Kirby	1915	Contributing		
1020 Kirby	1910	Contributing	Calvin Lake House	X
1000 block Kirby	1920	Contributing		
1019 Kirby	1890	Contributing	Leslie J. Coleman House	X
1015 Kirby	1890	Contributing	Robert Leake House (Cox House)	X
1008 Kirby		Non-Contributing		

Address	Date	Contributing/ Non-contributing Status	Historic Name	Calcasieu Historical Preservation Society Landmark
1002 Kirby	1920	Contributing		
1000 block Kirby	1915	Contributing		
923 Kirby	1900	Contributing		
Corner of Kirby and Bank	1910	Contributing		
917 Kirby	1915	Contributing		
916 Kirby		Non-contributing		
915 Kirby	1920	Contributing		
900 block Kirby	1920	Contributing		
909 Kirby	1920	Contributing		
905 Kirby	1915	Contributing	George Samuel Kreeger House	X
903 Kirby		Non-contributing		
902 Kirby	1890	Contributing	Rock House	X
Central School	1912	Contributing		
800 Kirby		Non-contributing		
742 Kirby	1920	Contributing		
730 Kirby	1920	Contributing		
715 Kirby	1920	Contributing		
700 block Kirby	1890	Contributing		
713 Kirby		Non-contributing		
714 Kirby		Non-contributing		
711 Kirby	1920	Contributing		
709 Kirby	1890	Contributing		
706 Kirby	1890	Contributing		
701 Kirby		Non-contributing		
631 Kirby	1920	Contributing		
625 Kirby		Non-contributing		
1036 Iris		Non-contributing		
1000 block Iris	1920	Contributing		
1034 Iris	1890	Contributing		

Address	Date	Contributing/ Non-contributing Status	Historic Name	Calcasieu Historical Preservation Society Landmark
1000 block Iris	1920	Contributing		
1025 Iris	1920	Contributing		
1000 block Iris	1920	Contributing		
1000 block Iris	1920	Contributing		
1013 Iris	1930	Contributing		
1014 Iris	1890	Contributing		
1000 block Iris		Non-contributing		
1003 Iris	1920	Contributing		
1000 block Iris	1890	Contributing		
930 Iris	1920	Contributing		
929 Iris	1920	Contributing		
921 Iris	1935	Contributing		
926 Iris		Non-contributing		
915 Iris	1920	Contributing		
924 Iris	1900	Contributing		
920 Iris		Non-contributing		
900 block Iris	1920	Contributing		
Corner Iris and Reid	1920	Contributing		
905 - 907 Iris	1920	Contributing		
832 Iris	1920	Contributing		
800 block Iris	1920	Contributing		
815 Iris		Non-contributing		
800 block Iris	1920	Contributing		
807 Iris	1930	Contributing		
316 Iris	1930	Contributing		
805 Iris	1920	Contributing		
904 Louisiana		Non-contributing		
765 Louisiana	1890	Contributing		
759 Louisiana	1910	Contributing		
1000 block Bank	1920	Contributing		

Address	Date	Contributing/ Non-contributing Status	Historic Name	Calcasieu Historical Preservation Society Landmark
816 Bank	1920	Contributing		
753 Bank		Non-contributing		
748 Bank	1920	Contributing		
749 Bank	1920	Contributing		
744 Bank		Non-contributing		
1009 Reid		Non-contributing		
1000 block Reid		Non-contributing		
911 Reid	1920	Contributing		
814 Reid		Non-contributing		
714 Reid	1910	Contributing		
712 Reid	1920	Contributing		
1112 Kirkman	1890	Contributing		
1104 Kirkman	1920	Contributing		
1036 Kirkman	1915	Contributing		
1032 Kirkman	1915	Contributing		
1000 block Kirkman	1920	Contributing		
1020 Kirkman	1935	Contributing		
Corner of Kirkman and Kirby Lane		Non-contributing		
1029 Kirkman	1920	Contributing		
1027 Kirkman	1920	Contributing		
1021 Kirkman		Non-contributing		
812 Kirkman		Non-contributing	First Methodist Church Rectory	
825 Kirkman	1920	Contributing		
823 Kirkman	1890	Contributing		
749 Kirkman		Non-contributing		
740 Kirkman	1905	Contributing		
746 Kirkman	1920	Contributing		
738 Kirkman	1900	Contributing		

Address	Date	Contributing/ Non-contributing Status	Historic Name	Calcasieu Historical Preservation Society Landmark
728 Kirkman	1910	Contributing		
722 Kirkman	1920	Contributing		
718 Kirkman	1910	Contributing		
714 Kirkman	1920	Contributing		
715 Kirkman	1896	Contributing	Episcopal Church of the Good Shepherd	X
626 Kirkman		Non-contributing		
Sowela Technical Institute	1939	Contributing		
520 Kirkman	1920	Contributing		
516 Kirkman	1900	Contributing		
512 Kirkman		Non-contributing		
510 Kirkman	1900	Contributing		
502 Kirkman	1900	Contributing		
910 Ford		Non-contributing		
800 block Ford		Non-contributing		
824 Ford		Non-contributing		
822 Ford	1910	Contributing		
739 Ford	1920	Contributing		
727 Ford	1920	Contributing		
725 Ford	1910	Contributing		
719 Ford	1920	Contributing		
711 Ford	1920	Contributing		
704 Ford		Non-contributing		
624 Ford	1903- 1909	Contributing	Walter S. Goos House	X
617 Ford	1930	Contributing		
618 Ford	1900	Contributing	Walter Goos House	X
600 block Ford		Non-contributing		
600 block Ford		Non-contributing		
522 Ford	1890	Contributing		

Address	Date	Contributing/ Non-contributing Status	Historic Name	Calcasieu Historical Preservation Society Landmark
521 Ford	1900	Contributing		
518 Ford	1900	Contributing		
	1888	Contributing	St. John's Lutheran Church	
512 Ford	1920	Contributing	James McCain House	X
513 Ford	1920	Contributing		
511 Ford		Non-contributing		
507 Ford	1915	Contributing		
503 Ford	1920	Contributing		
500 block Ford	1905	Contributing		
429 Ford	1890	Contributing		
427 Ford	1910	Contributing		
425 Ford	1920	Contributing		
420 Ford		Non-contributing		
400 block Ford	1910	Contributing		
414 Ford		Non-contributing		
413 Ford	1920	Contributing		
407 Ford		Non-contributing		
819 Moss	1910	Contributing		
817 Moss	1920	Contributing		
815 Moss	1920	Contributing		
700 block Moss		Non-contributing		
721 Moss	1920	Contributing		
724 Moss	1940	Non-contributing		
722 Moss	1910	Contributing		
707 Moss		Non-contributing		
618 Moss	1900	Contributing		
617 Moss	1890	Contributing	Piatz-Perry House	X
615 Moss	1930	Contributing		
600 block Moss	1900	Contributing		
500 block Moss		Non-contributing		

Address	Date	Contributing/ Non-contributing Status	Historic Name	Calcasieu Historical Preservation Society Landmark
511 Moss		Non-contributing		
Corner of Moss and Pine	1890	Contributing		
504 Moss	1900	Contributing		
427 Moss	1930	Contributing		
400 block Moss	1920	Contributing		
423 Moss	1920	Contributing		
420 Moss		Non-contributing		
417 Moss	1940	Non-contributing		
415 Moss	1910	Contributing		
400 block Moss	1930	Contributing		
400 block Moss	1930	Contributing		
300 block Moss		Non-contributing		
319 Moss	1890	Contributing		
314 Moss	1890	Contributing		
302 Moss	1900	Contributing		
Former Post Office / Courthouse	1910	Contributing		
Masonic Hall	1919	Contributing		
Temple Sinai	1903	Contributing		
		Non-contributing		
513 Hodges	1920	Contributing		
511 Hodges	1890	Contributing		
512 Hodges	1920	Contributing		
508 Hodges	1915	Contributing		
505 Hodges		Non-contributing		
502 Hodges	1905	Contributing		
430 Hodges		Non-contributing		
421 Hodges		Non-contributing		
424 Hodges		Non-contributing		
419 Hodges		Non-contributing		
415 Hodges		Non-contributing		

Address	Date	Contributing/ Non-contributing Status	Historic Name	Calcasieu Historical Preservation Society Landmark
420 Hodges		Non-contributing		
414 Hodges		Non-contributing		
411 Hodges	1920	Contributing		
400 block Hodges	1890	Contributing		
103 Hodges	1905	Contributing		
102 Hodges		Non-contributing		
321 Hodges		Non-contributing		
319 Hodges	1900	Contributing		
300 block Hodges	1890	Contributing		

APPENDIX E: SECRETARY OF THE INTERIOR'S STANDARDS FOR REHABILITATION

1. A property shall be used for its historic purpose or be placed in a new use that requires minimal change to the defining characteristics of the building and its site and environment.
2. The historic character of a property shall be retained and preserved. The removal of historic materials or alteration of features and spaces that characterize a property shall be avoided.
3. Each property shall be recognized as a physical record of its time, place, and use. Changes that create a false sense of historical development, such as adding conjectural features or architectural elements from other buildings, shall not be undertaken.
4. Most properties change over time; those changes that have acquired historic significance in their own right shall be retained and preserved.
5. Distinctive features, finishes, and construction techniques or examples of craftsmanship that characterize a property shall be preserved.
6. Deteriorated historic features shall be repaired rather than replaced. Where the severity of deterioration requires replacement of a distinctive feature, the new feature shall match the old in design, color, texture, and other visual qualities and, where possible, materials. Replacement of missing features shall be substantiated by documentary, physical, or pictorial evidence.
7. Chemical or physical treatments, such as sandblasting, that cause damage to historic materials shall not be used. The surface cleaning of structures, if appropriate, shall be undertaken using the gentlest means possible.
8. Significant archeological resources affected by a project shall be protected and preserved. If such resources must be disturbed, mitigation measures shall be undertaken.
9. New additions, exterior alterations, or related new construction shall not destroy historic materials that characterize the property. The new work shall be differentiated from the old and shall be compatible with the massing, size, scale, and architectural features to protect the historic integrity of the property and its environment.
10. New additions and adjacent or related new construction shall be undertaken in such a manner that if removed in the future, the essential form and integrity of the historic property and its environment would be unimpaired.

APPENDIX F: TREATMENT GUIDELINES FOR HISTORIC BUILDING MATERIALS

The *Secretary of the Interior's Standards* provide important guidelines and recommendations to establish a framework for responsible caretaking of the nation's cultural resources. They allow owners of historic properties, as well as architects, engineers, and others to make informed decisions regarding the conservation and protection of important building features in order to preserve the unique qualities and architectural character of historic buildings. The proper treatment of specific building materials provides the foundation for the continued preservation of this character. What follows is a brief summary of typical building materials that are utilized in the Charlestown Cultural District, along with guidelines for the proper maintenance of these materials. The recommendations were developed using the *Secretary of the Interior's Standards* and are generalized to address the most common issues encountered in the ongoing maintenance of a historic property. The introductory paragraph of each section also provides a recommendation on the preferred treatment of the element. The Technical Preservation Services Department of the National Park Service provides numerous publications that describe in greater detail accepted practices in the continued upkeep of historic building materials. Refer to the following website for a complete list of relevant Preservation Briefs and Technical Notes:

<http://www.nps.gov>

MASONRY

Many historic buildings and structures feature masonry exterior walls. The masonry walls of these properties contribute significantly to the overall architectural integrity of the historic district. It is important to maintain this significant feature through

the Preservation and Rehabilitation of the existing exterior building materials.

Recommendations to protect and maintain masonry are provided below:

1. Due to effects of the natural environment, most building surfaces require periodic cleaning. This cleaning can occur as part of a routine maintenance program, but should be undertaken on a very limited basis to prevent unnecessary deterioration and damage to exterior surfaces. It is most likely that cleaning will occur only prior to scheduled repainting of exterior materials. Tests must be conducted to ensure that the proposed method to clean the masonry surface does not contribute to the deterioration of the building element. The selected cleaning process must represent the gentlest method available to complete the task.
2. Some masonry walls within the historic district are painted, although this is likely not the historic finish. If painted, the painted surfaces must be properly maintained to protect the building element. Painting projects for the masonry exterior surfaces should include removal of damaged paint to the next sound layer using the gentlest technique available. This would include removal by hand-scraping or other accepted preservation techniques (chemical stripping). Techniques must be tested for compatibility with the building material to ensure that the process does not introduce unnecessary damage. New paint must be tested for its compatibility with the material to ensure a proper bond to the exterior

wall surface. The removal of paint from a historically painted masonry wall is not recommended.

3. Repair areas of damage as necessary. Cracks often occur through mortar joints, and it is important to conduct repairs using acceptable preservation techniques. Damaged mortar must be raked by hand and repointed as necessary using mortar of comparable strength, texture, and composition. Cracked masonry units can be consolidated using recognized conservation processes or replaced in-kind when damage is extensive. Replacement must use materials of similar size, scale, material composition, and profile to the original masonry unit.
4. When possible, damaged masonry units should be repaired by patching or consolidating the unit. Replacement of entire sections of masonry is not appropriate. If individual masonry units are damaged beyond repair, limited in-kind replacement of missing or damaged units can be undertaken. Replacement units must be similar in size, scale, composition, and color so that the masonry façade continues to convey a consistent architectural character.
5. Masonry buildings require periodic repointing to address the deterioration of mortar. When repointing, mortar must be raked by hand and repointed as necessary using mortar of comparable strength, texture, and composition. Lime-based mortar must not be replaced with Portland cement, which is significantly harder and can lead to the cracking of the adjacent masonry units. The new mortar joint must match the color, width, and depth of the original.

Hazardous materials. Any finish removal must consider the possibility that the finish to be removed could contain lead-based paint. State and Federal laws on lead paint abatement must be carefully considered and followed.

WOOD

Most historic buildings utilize some form of wooden elements in their construction. Significant decorative wood features include wood doors, windows, and trim. When used, they are significant, character-defining features that contribute to the overall historic character and architectural integrity of the resources. It is important to maintain these elements since they enhance the ability of the property to convey its significance and sense of the past.

Specific recommendations to maintain the architectural integrity of wood elements as part of a rehabilitation project include:

1. Maintain all painted surfaces. It is fortunate that most wood surfaces of buildings within the historic district feature a historically painted finish. Paint coatings help protect the wood from moisture infiltration and accelerated weathering caused by extensive sun exposure. Recommended pre-painting procedures include the following:
 - a. Remove peeling paint coatings when necessary, using the least invasive technique possible,
 - b. Sand (by hand) damaged paint coats to the next sound layer, and
 - c. Feather rough edges to ensure a clean and effective bond when repainting as part of a routine maintenance program.

2. Repair wood features as necessary, using accepted preservation techniques. This includes using epoxy, if possible, to repair deteriorated members, or replacing either missing or severely deteriorated wood elements with in-kind materials to match the historic element. Replacement elements must match the design and detailing of the original or historic feature as closely as possible, and they must be replicated using similar elements at the site as a template or through the use of historic photographs.
3. For wood elements that cannot be effectively repaired using the methods stated above, or if the existing element is missing, in-kind replacement is appropriate. The replacement of historic elements must be as compatible as possible with the existing wooden elements. When existing examples are available, reproduction to match historic features is possible.

Hazardous materials. Any finish removal must consider the possibility that the finish to be removed could contain lead-based paint. State and Federal laws on lead paint abatement must be carefully considered and followed.

STUCCO

A number of historic properties feature historic stucco as an exterior wall finish. This coating is a type of exterior plaster that is applied directly to a masonry wall, or wood or metal lathe in wood-frame buildings. The existing historic plaster consists of a three-coat system, applied directly to the exterior wall. The recommendations provided below conform to the *Secretary of the Interior's Standards* as well as *Preservation Brief 22: The Preservation and Repair of Historic Stucco*, provided by the National Park Service. Note that it is not appropriate to install

stucco to masonry buildings that did not feature this finish historically.

Portland/lime plaster: A plaster used until the early 1900s, consisting of two base coats (known as the scratch coat and the brown coat) of lime putty, sand, water, and a fibrous binder (usually animal hair) and a finish layer containing a higher proportion of lime putty and minimal aggregate. Lime plaster has a slow curing time and can take up to a year to cure. Typical job-mixed formulas are available; however, existing plaster composition should be verified prior to patching with a new plaster system.

Gypsum plaster: A plaster that gained prominence in the early twentieth century due to its quick curing time (it dries completely in two to three weeks). Gypsum plaster consists of gypsum combined with a variety of different additives and sand as the base-coat aggregate. Gypsum plaster does not require a fibrous binder in the base coat. The finish coat consists of lime putty and gypsum. Gypsum plaster must be protected from moisture and as a result, must be applied to masonry surfaces on top of furring strips to create an air space. Typical job-mixed formulas are available; however, existing plaster composition should be verified prior to patching with a new plaster system.

To determine the exact composition of the existing historic plaster, it is recommended that a sample of the plaster be sent to a testing agency. If this approach is not feasible, then a craftsman experienced with historic stucco could identify and recommend a suitable plaster to repair the existing finish. Proper repair of large areas of historic stucco must be conducted by a tradesman experienced in the art of plastering. A key task in the continued preservation of historic stucco is the upkeep of paint coatings

such as whitewashing, paraffin, or oil mastics. The continued installation of a surface coating will prolong the life for several reasons, such as offering additional stability for the stucco and filling cracks before they expand and damage an entire wall surface. Other key elements in the upkeep of historic stucco are as follows:

1. Assessing the specific causes of damage to the stucco surface before it causes significant deterioration. Deterioration can be caused by leaky gutters, vegetation, ground settlement and other issues, most of which involve the infiltration of water through the stucco surface. The cause of the damage must be repaired prior to any work involving the stucco.

2. When repair of the surface is required, testing must be done to determine the extent of repair necessary. Patching deteriorated areas of stucco is preferred to replacement of an entire stucco surface. Patching must follow accepted practices to ensure a proper bond with the existing stucco. New stucco must match the historic stucco in strength, composition, color, and texture.
3. Clean historic stucco by the gentlest means possible. Most surfaces can be adequately cleaned using a low-pressure water wash.

APPENDIX G: FEDERAL AND STATE TAX INCENTIVES REFERENCE GUIDE

Tax Incentive Programs			
	Historic Rehabilitation Tax Credit	Louisiana State Historic Preservation Tax Credit	Louisiana State Residential Rehabilitation Tax Credit
Purpose	Encourages the preservation of historic buildings through incentives to support the rehabilitation of historic and older buildings.	Encourages the preservation of historic buildings through incentives to support the rehabilitation of historic and older buildings.	Encourages taxpayers to preserve and improve their homes by offering a tax credit on rehabilitation costs
Eligibility	Income producing property individually listed on the National Register (NR) or a contributing element within a National Register Historic District	Income producing property that is a contributing element within a Downtown Development District or Cultural District as determined by the Division of Historic Preservation.	An owner occupied building that is a contributing element to a NR District, a locally designated historic district, a Main Street District, a Cultural District, or a DDD; a residential structure that is listed or is eligible for listing in the NR; or a vacant and blighted building at least 50 years old
% of Credit	20% of construction costs and fees GO Zone- 26% for costs incurred from August 28, 2005 through December 31, 2011.	25%	25% of construction costs and fees. 50% of construction costs and fees IF the building is qualified as vacant and blighted.
Minimum Expenditure	The rehabilitation must exceed the adjusted basis of the building. If adjusted basis is less than \$5,000, the rehabilitation cost must be at least \$5,000.	\$10,000	\$10,000
Credit Cap	None	\$5 million per taxpayer within a particular district.	\$25,000 per structure
Application	Submitted to DHP and forwarded to NPS with recommendation. Part 1 certifies the building as historic. Part 2 describes the proposed rehabilitation. Part 3 is final certification of completed work.	Submitted to DHP. Part 1 certifies the building as historic. Part 2 describes the proposed rehabilitation. Part 3 is final certification of completed work.	Preliminary Application-A establishes initial eligibility. Proposed Rehabilitation Application-B determines if the proposed rehabilitation is consistent with the Standards. Certificate of Completion-C is the final certification.
Fees	Initial fee request by NPS of \$250 with Part 2; final fee is scaled to the size of the rehabilitation	\$250 with Part 2	\$250 with Proposed Rehabilitation Application-B
Program Standards	Secretary of the Interior's Standards for Rehabilitation	Secretary of the Interior's Standards for Rehabilitation	Secretary of the Interior's Standards for Rehabilitation
Taking the Credit	Credit is claimed for the year the project is completed and has received an approved Part 3. Unused Credit can be carried back one year and forward for 20 years.	Credit is claimed for the year the project is completed and has received an approved Part 3. Any unused credit may be carried forward for up to 5 years. This credit may be sold to a third party.	The tax credit is divided into 5 equal portions, with the first portion being used in the taxable year of the completion date, and the remaining portions used once a year for the next four years. If the full credit for one year cannot be taken, the owner will receive that amount as a refund.
Recapture	If the owner sells the building within 5 years of the rehabilitation, he loses 20% of the earned credit for each year short of the full 5 years.	If the owner sells the building within 5 years of the rehabilitation, he loses 20% of the earned credit for each year short of the full 5 years.	If the building is sold during the five-year credit period, all unused credit will immediately become void.

APPENDIX H: ADDITIONAL RESOURCES

City of Lake Charles/Calcasieu Parish Resources

- Lake Charles Historic Preservation Commission
(<http://www.cityoflakecharles.com/department/board.php?fDD=13-253>)
- Planning and Zoning Commission
(<http://www.cityoflakecharles.com/department/board.php?fDD=13-89>)
- Permit Center
(<http://www.cityoflakecharles.com/department/?fDD=18-0>)
- Downtown Development
(<http://www.cityoflakecharles.com/department/?fDD=7-0>)
- Smart Code
(<http://www.cityoflakecharles.com/department/division.php?fDD=7-50>)
- Zoning Ordinance for the City of Lake Charles
(http://www.cityoflakecharles.com/egov/docs/1321550243_861602.pdf)
- Calcasieu Historical Preservation Society
(http://calcasieupreservation.com/index.php?option=com_content&view=article&id=26&Itemid=16)
- Charpentier Historic District
(<http://www.cityoflakecharles.com/department/division.php?fDD=3-32>)

(<http://www.cityoflakecharles.com/department/division.php?fDD=7-51>)

Preservation Resources

Websites apt to change over time – as of January 2012:

National Park Service (NPS) (<http://www.nps.gov>)

(NPS) Technical Preservation Services
(<http://www.nps.gov/history/hps/tps/index.htm>)

(NPS) The Secretary of the Interior’s Standards for Rehabilitation
(<http://www.nps.gov/hps/tps/tax/rehabstandards.htm>)

(NPS) Illustrated Rehabilitation Guidelines
(<http://www.nps.gov/hps/tps/tax/rhb/index.htm>)

(NPS) Interpreting the Standards Bulletins
(<http://www.nps.gov/hps/tps/tax/ITS/itshome.htm>)

(NPS) Preservation Briefs
(<http://www.nps.gov/hps/tps/briefs/presbhom.htm>)

(NPS) Federal Rehabilitation Tax Credit
(<http://www.nps.gov/history/hps/tps/tax/incentives/index.htm>)

General Services Administration (GSA)
(<http://www.gsa.gov/portal/category/20992>)

National Trust for Historic Preservation (NTHP)
(<http://www.preservationnation.org/>)

Public Art Resources

Project for Public Spaces (<http://www.pps.org/>)

Historical Resources

Cormier, Adley. "A Timeline History of Lake Charles and Southwest Louisiana."
(http://www.calcasieupreservation.org/index.php?option=com_content&view=article&id=2&Itemid=3)

Gremillion, John Berton. "Calcasieu Parish."
(<http://library.mcneese.edu/depts/archive/FTBooks/gremillion-calcasieu2.htm>)

Lake Charles Historic District National Register of Historic Places nomination.

Usher, Angela and Anne Hurley. Charpentier Historic District Survey. March 1985.
(http://www.cityoflakecharles.com/egov/docs/1318269762_369110.pdf)

Books and Publications

"Reviewing New Construction Projects in Historic Areas." Information Series No. 62. Washington, D.C.: National Trust for Historic Preservation, 1992.

Bowsher, Alice Meriwether. *Design Review in Historic Districts*. Washington, D.C.: The Preservation Press, 1980.

Ching, Francis D.K. *Building Construction Illustrated*. New York: Van Nostrand Reinhold Company, 1975.

Fricker, Jonathan, Donna Fricker, and Patricia L. Duncan. *Louisiana Architecture: A Handbook on Styles*. Lafayette: Center for Louisiana Studies, 1998.

Harris, Cyril, ed. *Dictionary of Architecture and Construction*. New York: McGraw-Hill, 2000.

Longstreth, Richard. *The Buildings of Main Street: a guide to American commercial architecture*. Washington: Preservation Press, 1987.

National Trust for Historic Preservation. *Repair or Replace Old Windows: A Visual Look at the Impacts*. (http://www.preservationnation.org/issues/weatherization/windows/additional-resources/nthp_windows_repair_replace.pdf)

Old & new architecture: design relationship: from a conference sponsored by National Trust for Historic Preservation, Latrobe Chapter, Society of Architectural Historians and the Washington Metropolitan Chapter, American Institute of Architects. Washington, D.C.: Preservation Press, National Trust for Historic Preservation, 1980.

Saylor, Henry H. *Dictionary of Architecture*. New York: John Wiley & Sons, 1952.

University of New Orleans, Center for Economic Development. *The Economic Benefits of Historic Preservation in Louisiana: measuring the impacts of a local economic development strategy*. New Orleans: Center for Economic Development, 1999.

Urban Design Associates. *Louisiana Speaks: Pattern Book*.
(http://www.cityoflakecharles.com/egov/docs/1258672241_63659.pdf)

Weeks, Kay D. and Anne E. Grimmer. *The Secretary of Interior's Standards for the Treatment of Historic Properties with Guidelines for Preserving, Rehabilitating, Restoring and Reconstructing Historic Buildings*. Washington, D.C.: U.S. Department of the Interior, National Park Service, Cultural Resource Stewardship and Partnerships, Heritage Preservation Services, 1995.



RANDY ROACH
MAYOR

CITY OF LAKE CHARLES

326 Pujot St. – P.O. Box 900
Lake Charles, LA 70602-0900
(337) 491-1542 – FAX (337) 491-9187

PLANNING DEPARTMENT
OFFICE OF ZONING & LAND USE

ITEMS NECESSARY FOR PLANNING COMMISSION/CONDITIONAL USE PERMIT APPLICATION

1. **Scaled Site Plan:** 1" = 10' or 1" = 20'
Site Plan should address the following:
 - a. Dimensions of structure(s) – proposed & existing
 - b. Dimensions of parcel
 - c. Setbacks of structure(s) from each property line
 - d. Proposed and/or existing curb cuts, parking facilities, & buffering
 - e. Adjacent property land uses

****If site plan is larger than 11" x 17", fifteen (15) copies are required****
(We do not have the equipment to copy large plans. Please draw plans on regular white paper or blue line----no cardboard, etc.)
2. **Vicinity Plan** – (can normally be found in abstract) – Must be included in all new construction applications.
3. **Current legal description of property**
4. **Letter of Intent by Applicant**
Letter should include the following:
 - a. Name and address of applicant
 - b. Location and description of development and/or proposed establishment
 - c. Signature of applicant
5. **Verification of Ownership and/or Owner's Consent Letter**
6. **Names and addresses** of property owners within **500 feet** of proposed establishment and/or development. (This can be obtained from the Calcasieu Parish Tax Assessors Office for a fee.)
NOTE: Required for Major Permits or Planned Developments only.
 - A. Conditional Use Permits: Minor - \$ 75.00
Major - \$250.00
 - B. Planned Developments: Minor - \$200.00
Major - \$250.00
 - C. Variances \$200.00
 - D. Special Exceptions \$200.00
 - E. Appeals \$100.00
 - F. Amendments (Rezoning) \$500.00 up to 5 acres
\$ 50.00 for each successive acre up to \$2,000.00

All items are to be filed with our office before the cut-off date:

Cut-Off Date: _____
Meeting Date: _____

Should you have any questions or require additional information, please contact the Office of Zoning and Land Use at: Phone: (337) 491-1542 Fax: (337) 491-9187.

CITY OF LAKE CHARLES, LOUISIANA
LAKEFRONT/DOWNTOWN DEVELOPMENT REVIEW

DATE:
APPLICANT:
PHONE 337-
Fax 337-

MAILING ADDRESS:

SUBJECT PROPERTY OWNER OF RECORD:
SUBJECT PROPERTY ADDRESS:
LEGAL DESCRIPTION (NEW CONSTRUCTION ONLY):

CHARACTER & NATURE OF PROPOSED USE (ATTACH FULL SET OF CONSTRUCTION PLANS WITH ELEVATIONS):

TRANSECT ZONES: T3 – SUB-URBAN T4 – GENERAL URBAN
 T5 – URBAN CENTER T6 - URBAN CORE
 CIVIC FUNCTION – VARIANCE REQUIRED
 SPECIAL DISTRICT – VARIANCE REQUIRED

PROPOSED DEVIATIONS/INCONSISTENCES FROM APPLICABLE DOWNTOWN DEVELOPMENT STANDARDS AS FOLLOWS:

Code Section	Deviation Requested	Recommendation
<p>PROPOSED DEVIATIONS/INCONSISTENCES ARE JUSTIFIED BY AND/OR FURTHER THE FOLLOWING POLICIES. (CHECK ALL THAT APPLY)</p> <p>SMART CODE ARTICLE 1, SECTION 1.2.1, THE REGION</p>		
<input type="checkbox"/>	a. That the region should retain its natural infrastructure and visual character derived from topography, woodlands, farmlands, riparian corridors and coastlines.	
<input type="checkbox"/>	b. That growth strategies should encourage Infill and redevelopment in parity with new communities.	
<input type="checkbox"/>	c. That development contiguous to urban areas should be structured in the Neighborhood pattern and be integrated with the existing urban pattern.	
<input type="checkbox"/>	d. That development non-contiguous to urban areas should be organized in the pattern of clusters, traditional Neighborhoods or Villages, and Regional Centers.	
<input type="checkbox"/>	e. That affordable housing should be distributed throughout the region to match job opportunities and to avoid concentrations of poverty.	
<input type="checkbox"/>	f. That transportation corridors should be planned and reserved in coordination with land use.	
<input type="checkbox"/>	g. That green corridors should be used to define and connect the urbanized areas.	
<input type="checkbox"/>	h. That the region should include a framework of transit, pedestrian, and bicycle systems that provide alternatives to the automobile.	

SMART CODE ARTICLE 1, SECTION 1.2.2, THE COMMUNITY

- a. That Neighborhoods and Regional Centers should be compact, pedestrian-oriented and mixed-use.
- b. That Neighborhoods and Regional Centers should be the preferred pattern of development and that districts specializing in single-use should be the exception.
- c. That ordinary activities of daily living should occur within walking distance of most dwellings, allowing independence to those who do not drive.
- d. That interconnected networks of Thoroughfares should be designed to disperse and reduce the length of automobile trips.
- e. That within Neighborhoods, a range of housing Types and price levels should be provided to accommodate diverse ages and incomes.
- f. That appropriate building Densities and land uses should be provided within walking distance of transit stops.
- g. That Civic, institutional, and Commercial activity should be embedded in Down- towns, not isolated in remote single-use complexes.
- h. That schools should be sized and located to enable children to walk or bicycle to them.
- i. That a range of open space including parks, squares, and playgrounds should be distributed within Neighborhoods and urban center zones.

SMART CODE ARTICLE 1, SECTION 1.2.3, THE BLOCK AND THE BUILDING

- a. That buildings and landscaping should contribute to the physical definition of Thoroughfares as Civic places.
- b. That development should adequately accommodate automobiles while respecting the pedestrian and the spatial form of public space.
- c. That the design of streets and buildings should reinforce safe environments, but not at the expense of accessibility.
- d. That architecture and landscape design should grow from local climate, topography, history, and building practice.
- e. That buildings should provide their inhabitants with a clear sense of geography and climate through energy efficient methods.
- f. That Civic Buildings and public gathering places should be provided locations that reinforce community identity and support self-government.
- g. That Civic Buildings should be distinctive and appropriate to a role more important than the other buildings that constitute the fabric of the city.
- h. That the preservation and renewal of historic buildings should be facilitated to affirm the continuity and evolution of society.
- i. That the harmonious and orderly evolution of urban areas should be secured through graphic codes that serve as guides for change.

REMARKS OR SPECIAL CONDITIONS:

CHAIRMAN DESIGN REVIEW / DOWNTOWN DEVELOPMENT AUTHORITY Ex. Director _____ DATE _____

- PERMIT IS HEREBY GRANTED
- WARRANT REQUIRED
- WARRANT APPROVED WARRANT DENIED
- VARIANCE REQUIRED (PUBLIC HEARING PROCESS MUST BE INITIATED)

REMARKS OR SPECIAL CONDITIONS:

PLANNING DIRECTOR _____ DATE _____

IT IS HEREBY AGREED UPON THAT MY DEVELOPMENT PERMIT IS CONTINGENT UPON MY COMPLIANCE WITH ALL APPLICABLE CODES, REGULATIONS, AND POLICIES OF THE CITY OF LAKE CHARLES. ANY ATTEMPT TO ABROGATE SUCH OR FAILURE TO COMPLY WITH ANY CONDITION LEGALLY IMPOSED AND INCORPORATED INTO THIS PERMIT AND/OR WARRANT WILL RENDER MY PERMIT NULL AND VOID.

APPLICANT _____ DATE _____